

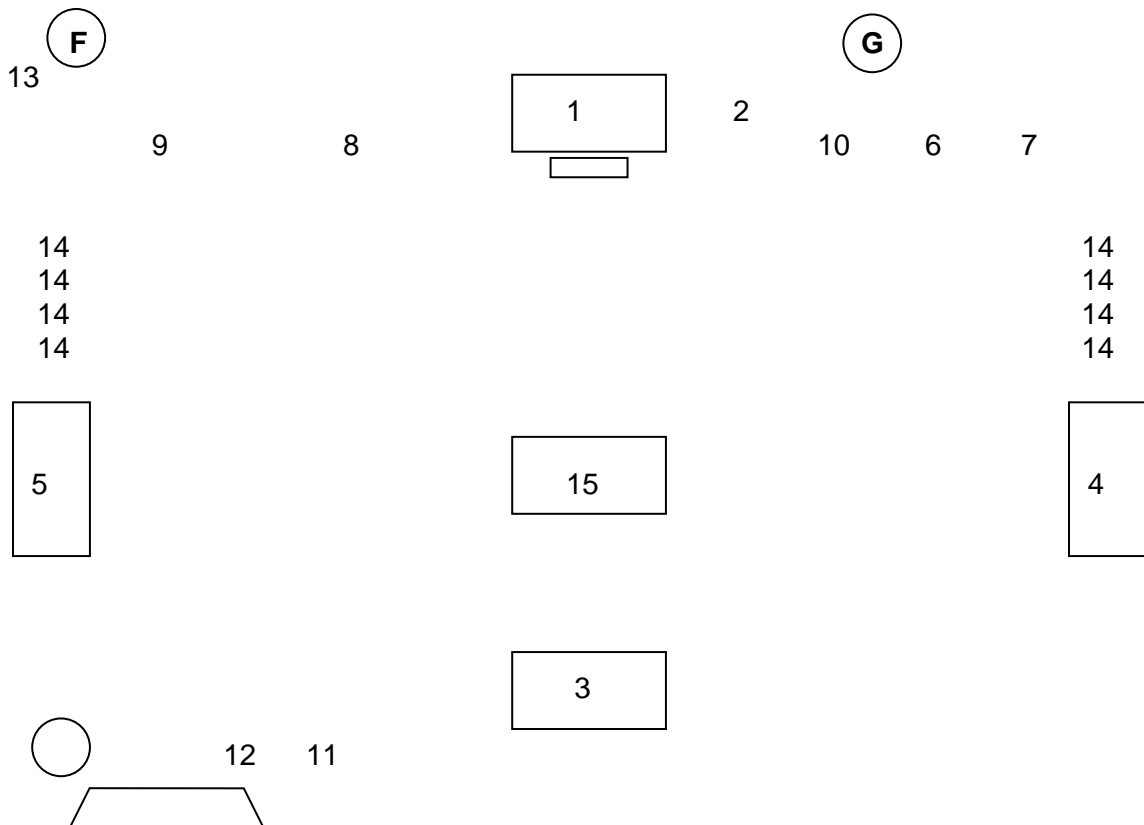
**SECTION 5**

**KEY TO ALL DIAGRAMS**

- 1. Lodge President/Honoured Royal Lady
- 2. Immediate Past President/Immediate Past Honoured Royal Lady
- 3. 1st Vice President/Associate Royal Lady
- 4. 2nd Vice President/Loyal Lady
- 5. 3rd Vice President/Lecturing Lady
- 6. Secretary
- 7. Treasurer
- 8. Chaplain
- 9. Historian (appointed)
- 10. Conductress
- 11. Inner Guard
- 12. Outer Guard or Guard
- 13. Pianist (appointed, optional)
- 14. Drill Team
- 15. Centre Station
- F. Canadian Flag
- G. Canadian Royal Purple Society Flag

*Position of the Pianist will vary in Lodge rooms due to location of the piano.*

**DIAGRAM 1**



**INSTRUCTIONS FOR THE INSTALLING OFFICER WHO IS INSTALLING AN OFFICER WHO WAS ABSENT FROM THE INSTALLATION CEREMONY.**

**PRESIDENT/HONOURED ROYAL LADY** – *(turning to the Installing Officer on her right, who rises).*  
Installing Officer, I now place in your hands the emblem of power and resign to you the station and duties of Presiding Officer of this Lodge.

**INSTALLING OFFICER** – By virtue of the authority vested in me, I shall now proceed with the Installation of the \_\_\_\_\_ of this Lodge. I hereby appoint \_\_\_\_\_ as Assistant Installing Officer, \_\_\_\_\_ as Installing Secretary and \_\_\_\_\_ as Installing Pianist.

**INSTALLING OFFICER** – Assistant Installing Officers, please take your places.

**INSTALLING OFFICER** – Installing Secretary, you will call the name(s) of the \_\_\_\_\_ member(s) for the ensuing term *(if more than one is being installed all names should be called.)*

**INSTALLING OFFICER** – Assistant Installing Officer, assisted by the Drill Team, please present the elected and appointed (positions) \_\_\_\_\_ to the Centre Station.

*(Installing Officer goes to Centre Station)*

**INSTALLING OFFICER** – \_\_\_\_\_ you have been elected to the position of \_\_\_\_\_. Do you signify your willingness to accept the position to which you have been chosen? If so, answer “I do”.

**INSTALLING OFFICER** – You will assume the Obligation Sign, pronounce your name and repeat after me:

**INSTALLATION OBLIGATION**

I, \_\_\_\_\_ promise to fulfill the duties of the position to which I have been chosen. I will endeavor to promote the interests of the Society and increase its Membership. I promise to deal honestly with this Lodge, its Members, and the National Office. At the end of my term I will deliver all property of the Lodge in my possession to my successor or to the duly authorized representative of the Society. All this I promise to fulfill to the best of my ability.

*(Installing Officer returns to their position)*

**INSTALLING OFFICER** –Member(s), it becomes my duty to call your attention to the Regulations of the Society, which completely set forth the duties of all Directors (Officers). It is required that these articles must be carefully read before the next regular meeting of this Lodge in order to acquaint yourself with your duties. Assistant Installing Officer, you will present the \_\_\_\_\_ for further instructions.

**ASSISTANT INSTALLING OFFICER** – Installing Officer, it gives me great pleasure to present to you, \_\_\_\_\_ who has been chosen for the position of \_\_\_\_\_ for the ensuing term.

*(Installing Officer – will now give the proper charge to the Officer(s) absent as per Installation Ceremony).*

**INSTALLING OFFICER – Chaplain, we will close this ceremony in prayer.**

**DIRECTOR (CHAPLAIN) – Oh Lord, Bless the Officers who have taken their Obligation(s) and give them wisdom and strength as they perform their duties throughout the year. Amen**

**INSTALLING OFFICER – Now, by virtue of the authority vested in me, I declare the Officers of \_\_\_\_\_ Lodge No. \_\_\_\_\_ of the Canadian Royal Purple Society installed for the ensuing term or until their successors shall be chosen and duly installed.**

**INSTALLING OFFICER – President/Honoured Royal Lady, I now surrender into your keeping the gavel, and I trust that your Lodge may have a very prosperous year.**

### **INSTALLATION OF THE DISTRICT DEPUTY**

The newly elected District Deputy will be installed at the District Meeting by the current District Deputy, the appointed Election Chairman or a member of the District Deputy Elect's choice

**INSTALLING OFFICER – (-O-) This District Meeting will come to order. Secretary, you will call the name of the District Deputy elect whose term of office will begin immediately.**

*Secretary will call the name of the District Deputy elect*

**INSTALLING OFFICER – Conductress you will escort the District Deputy elect to my position accompanied by the Drill Team. (-O-O-O-)**

*The Conductress, assisted by the Drill Team, will escort the District Deputy elect around the room and past the Centre Station to the Installing Officers position.*

**CONDUCTRESS – Installing Officer \_\_\_\_\_ it gives me great pleasure to present to you (Title) \_\_\_\_\_, who has been chosen by the delegates for the position of District Deputy for the ensuing term.**

*Conductress steps back after presenting the incoming District Deputy.*

**INSTALLING OFFICER – \_\_\_\_\_, you have been chosen by the delegates of District No \_\_\_\_\_ as District Deputy for the coming year. You will be the link between the District and the Lodges in your District. It will be your duty to provide leadership, promote proper procedures, encourage all activities, and assist each Lodge through any difficulties, practicing the principles of Justice, Charity, Love and Service. By using tact and discretion, endeavour to be fair, compassionate, and understanding. During your term of office, you will follow all instructions given to you by the National Office. At the end of your term, you will be required to deliver all pertinent files to your successor and give any assistance required by your successor.**

**INSTALLING OFFICER – Conductress, you will escort the District Deputy Elect to a seat at my right. (Optional –may return to their seat). (-O-)**

*Conductress and Drill Team will escort the District Deputy Elect around the room to a seat at the right of the Presiding Officer or return the District Deputy to their seat.*

*At this time, the Drill Team will return to their seats and the District Deputy Drill will be performed.*

## **DRILLS**

### **GENERAL INSTRUCTIONS**

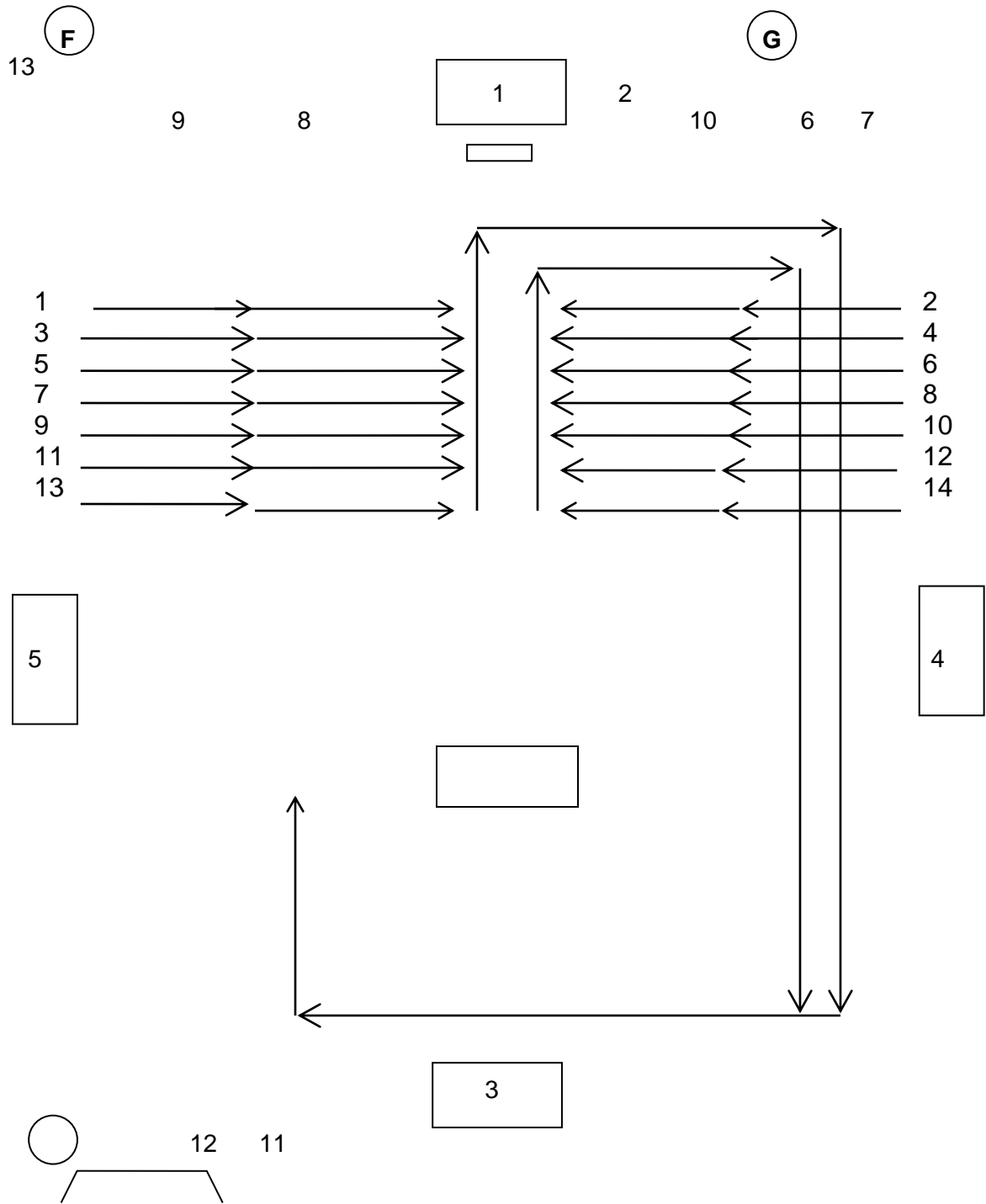
The following Drills are presented merely as a guideline and may be adapted to suit such situations as:

1. Number of Members available to perform Drills;
2. Size of Hall;
3. Function at which the Drill is performed.
4. Leaders of Drill Teams stand with their hands at their sides
5. When exemplifying drills, the Drill Team members may place their left hand on the right shoulder of the Drill Team Member directly in front of them, with their right arm parallel to their waist.

In all Drills, kneeling shall be optional and the necessary adjustment made.

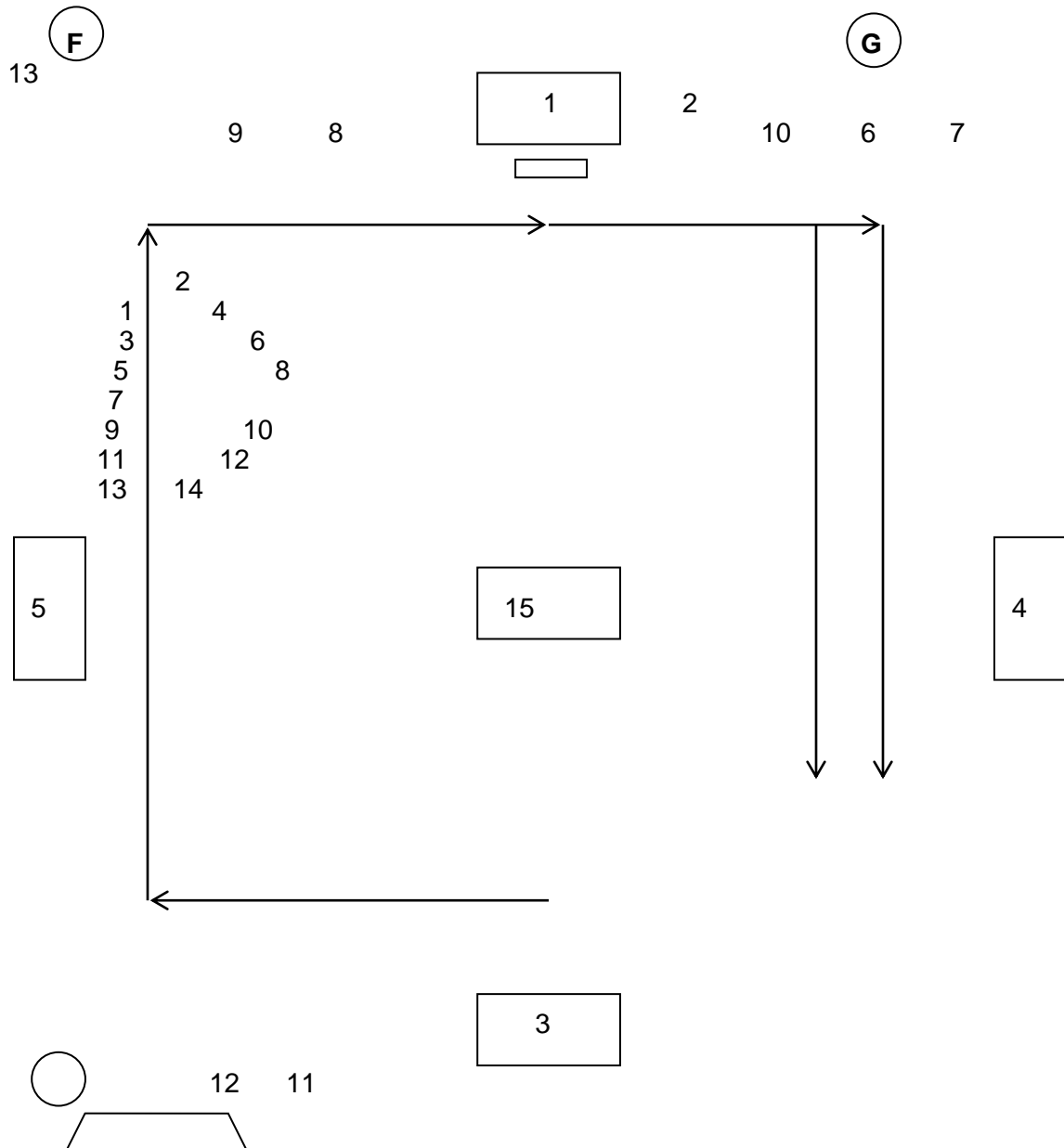
Discretion and common sense shall be applied to cover extraordinary circumstances and situations in all Drills.

**Diagram 2 - DISTRICT DEPUTY DRILL**  
**DRILL TEAM STARTING DRILL WITH LETTER 'D'**



**DIAGRAM 3 – District Deputy Drill**

**FORMING THE LETTER 'D'**

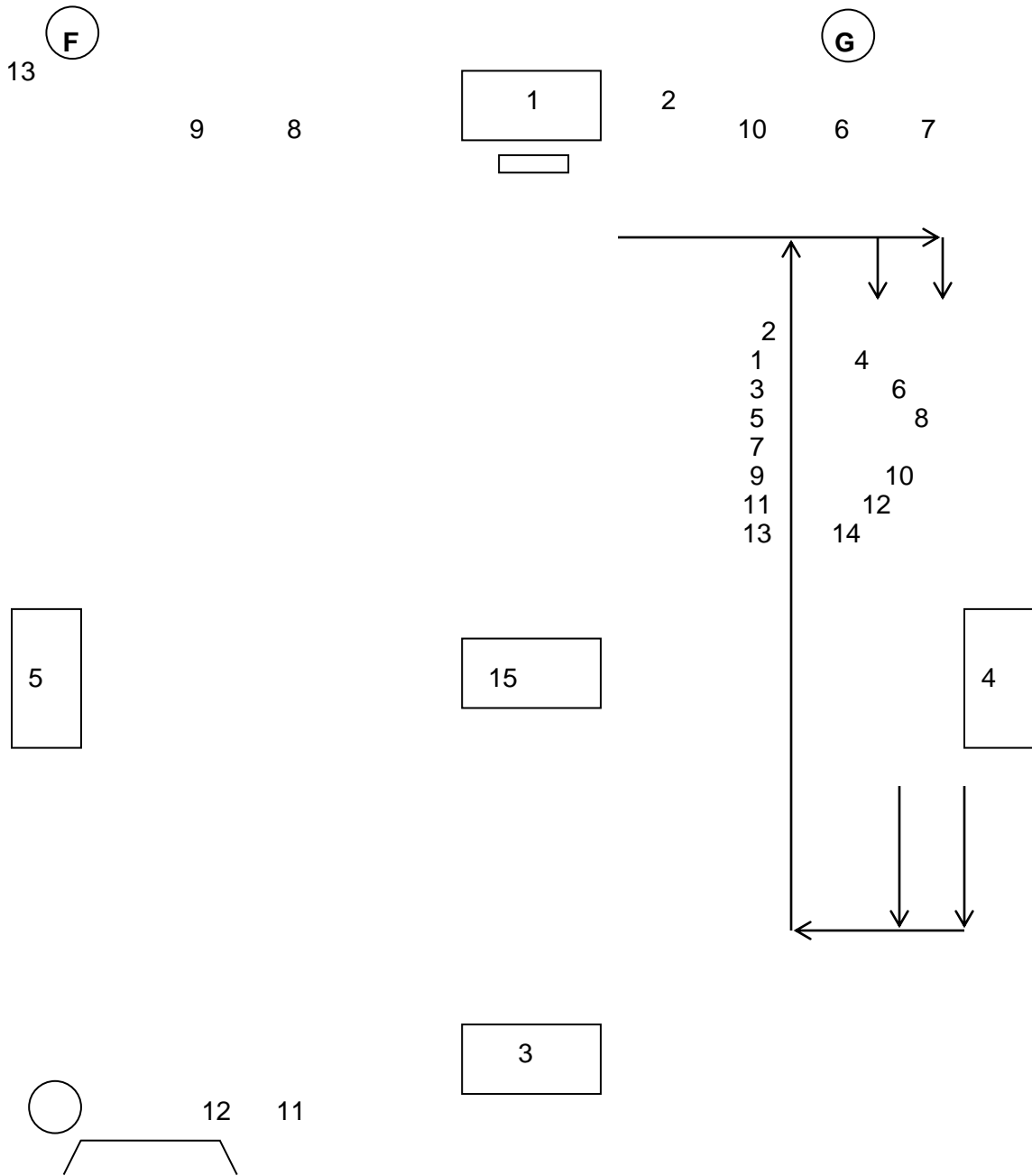


**Past District Deputy:**

'D' is for **District**  
 Each Lodge we hold dear.  
 And try to encourage  
 Right through the year.

**DIAGRAM 4 - District Deputy Drill**

**FORMING THE LETTER 'D'**

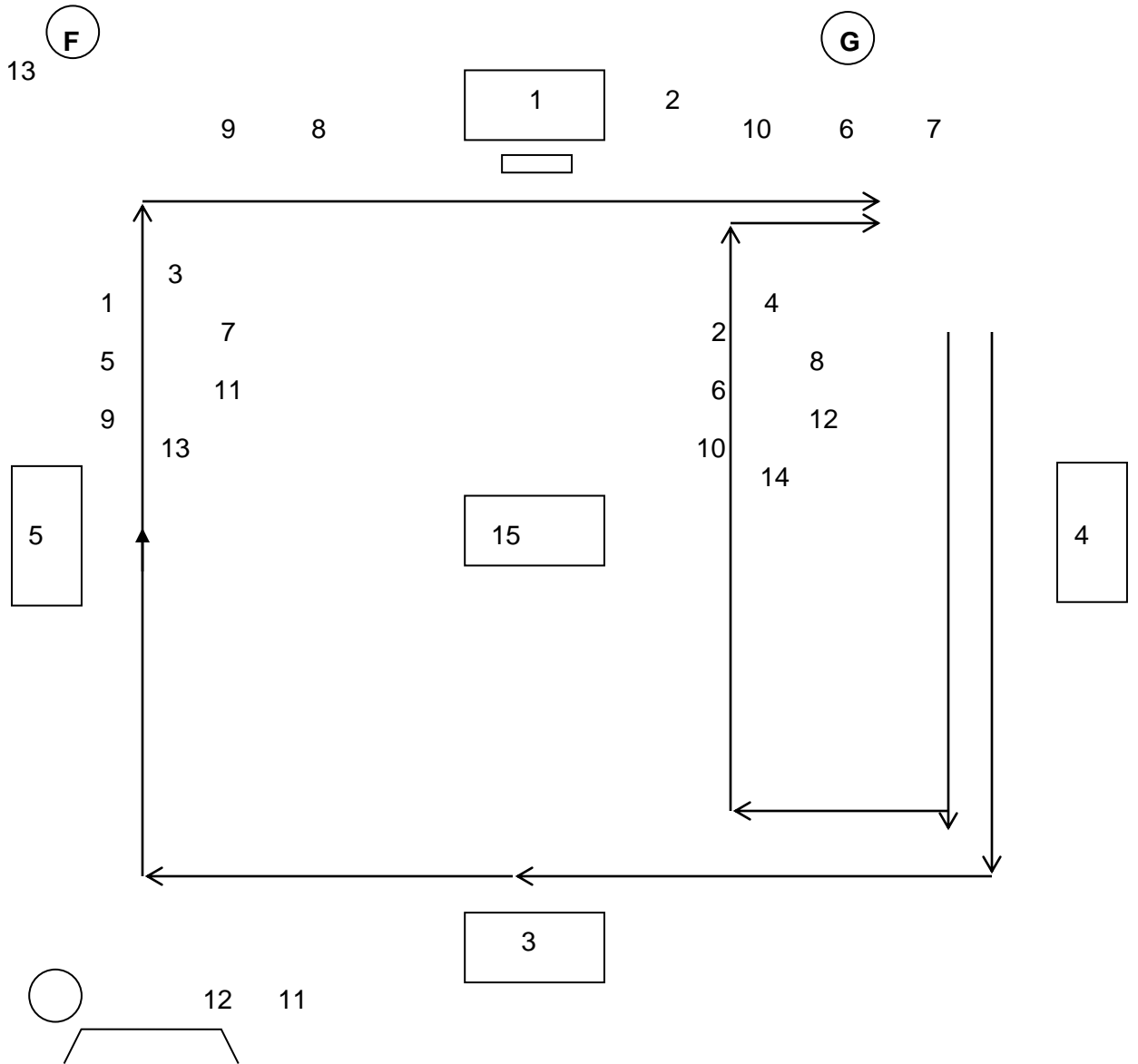


**Past District Deputy:**

'D' is for **Deputy**, thoughtful and kind,  
 Ever attentive to problems they'll find.  
 Promoting our principles  
 Understanding and true.  
 To the laws of Purpledom  
 Your year will shine through.

**DIAGRAM 5 - District Deputy Drill**

**FORMING DOUBLE 'D's'**



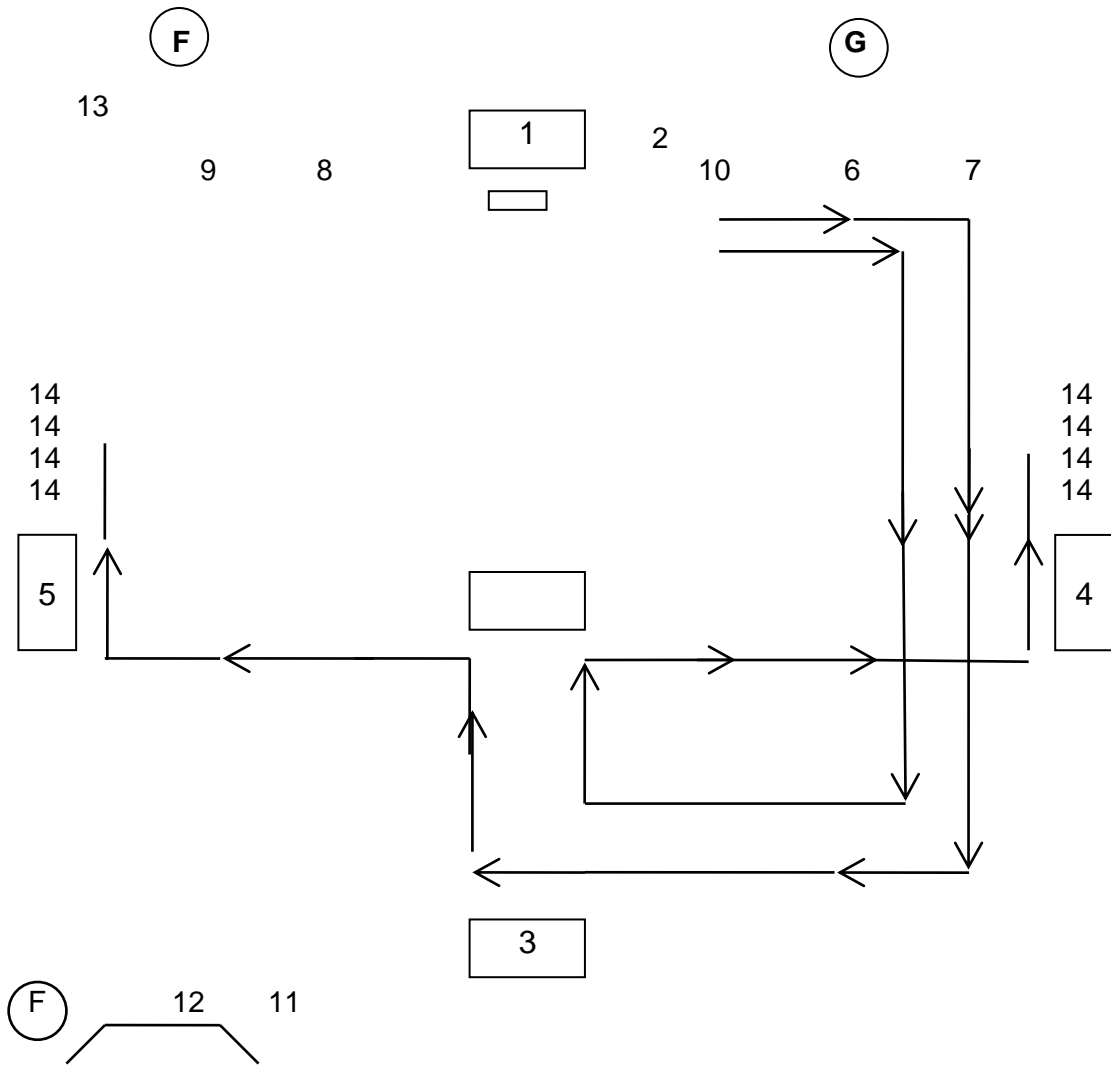
**Past District Deputy:**

District Deputy \_\_\_\_\_  
 We welcome you here  
 And look to the future  
 Of your guiding year.  
 Assist us, support us and when all is done,  
 Remember us all, as your friends, everyone.

*The Drill Team continues in pairs until they reach the bottom corner, and then continue to form the Double D's, one on the left side and one on the right side.*



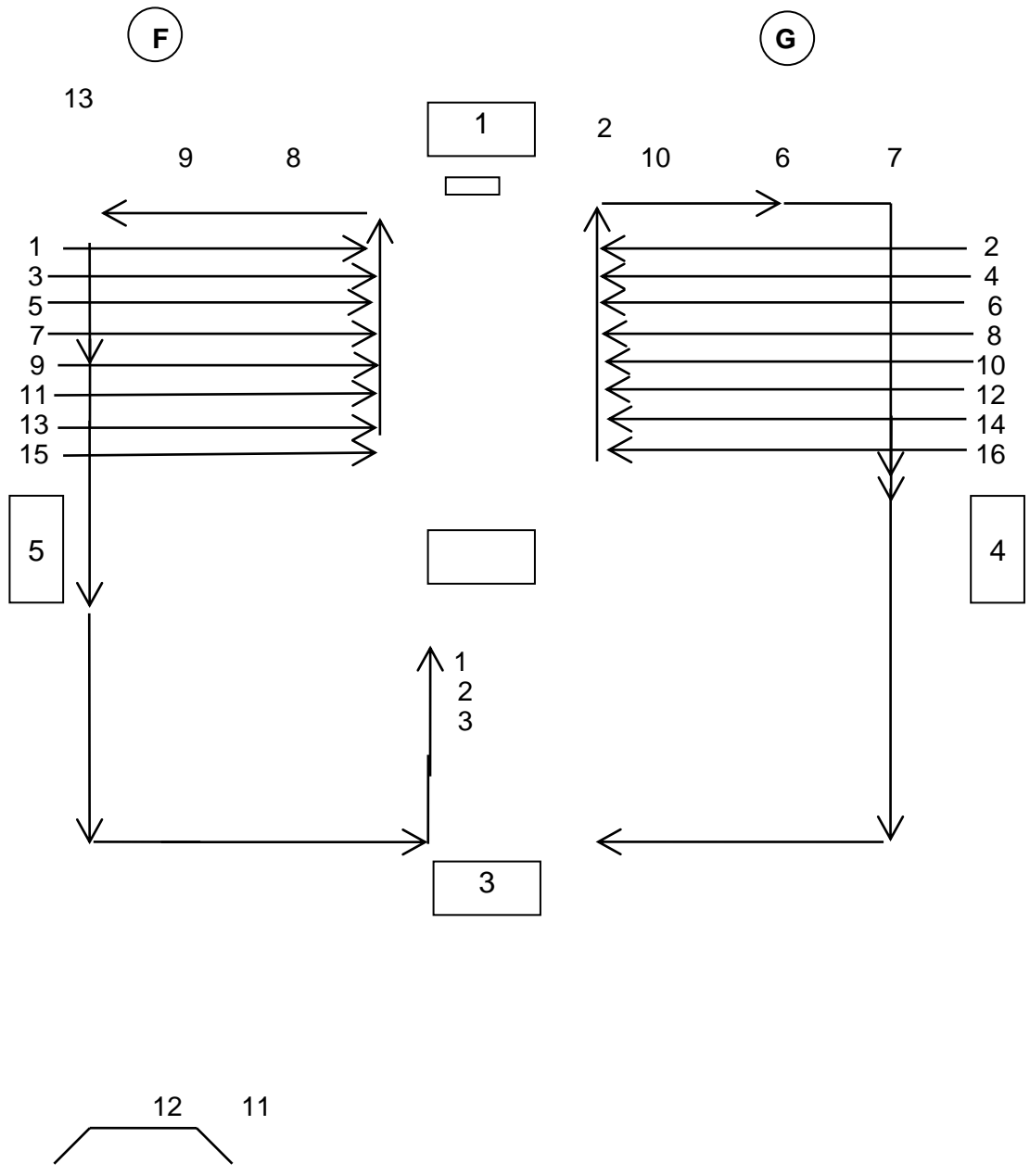
DIAGRAM 6 - District Deputy Drill



### Pansy Drill

When first chord is sounded on piano, the Drill Team will rise. Numbers 1 and 2 move the Centre Station and return to their places. As each letter is formed by the Drill Team the President/Honoured Royal Lady repeats the corresponding words.

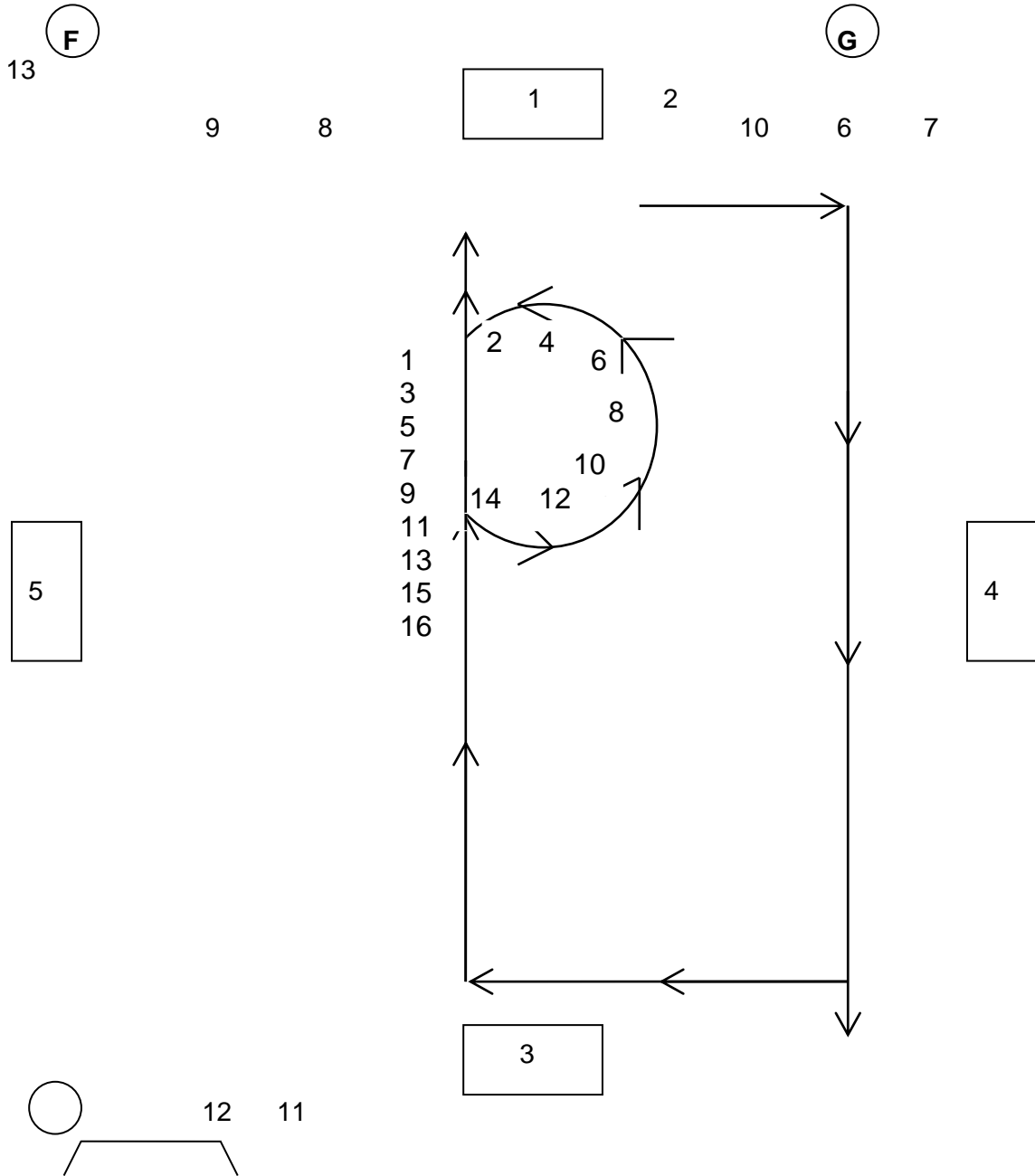
**DIAGRAM 7 – OPENING OF PANSY DRILL**



**DIAGRAM 8 – Pansy Drill**

**FORMING THE LETTER ‘P’**

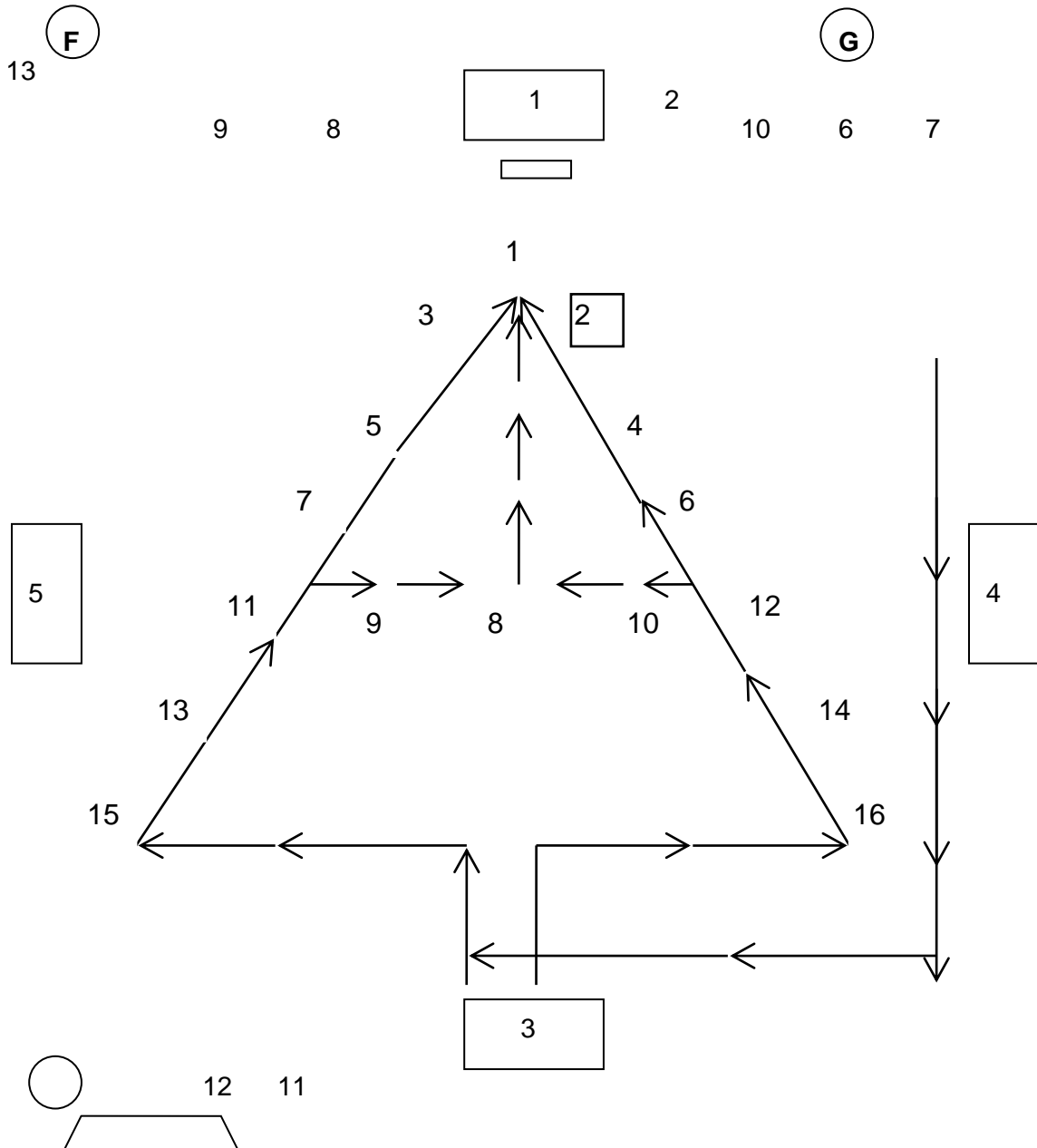
*The left hand is placed on the right shoulder with the right forearm parallel to waist.*



**President/Honoured Royal Lady – ‘P’** is for the **Purple Pansy**, the floral emblem of our Organization.

**DIAGRAM 9 - Pansy Drill**  
**FORMING THE LETTER 'A'**

*Numbers 8, 9 and 10 form bar of letter 'A'. Number 8 extends hands to rest on shoulder of Number 9 and Number 10. Number 9 and Number 10 rest hands in their lap. Team leaves in single file. Numbers 8, 9 and 10 fall in at the point.*

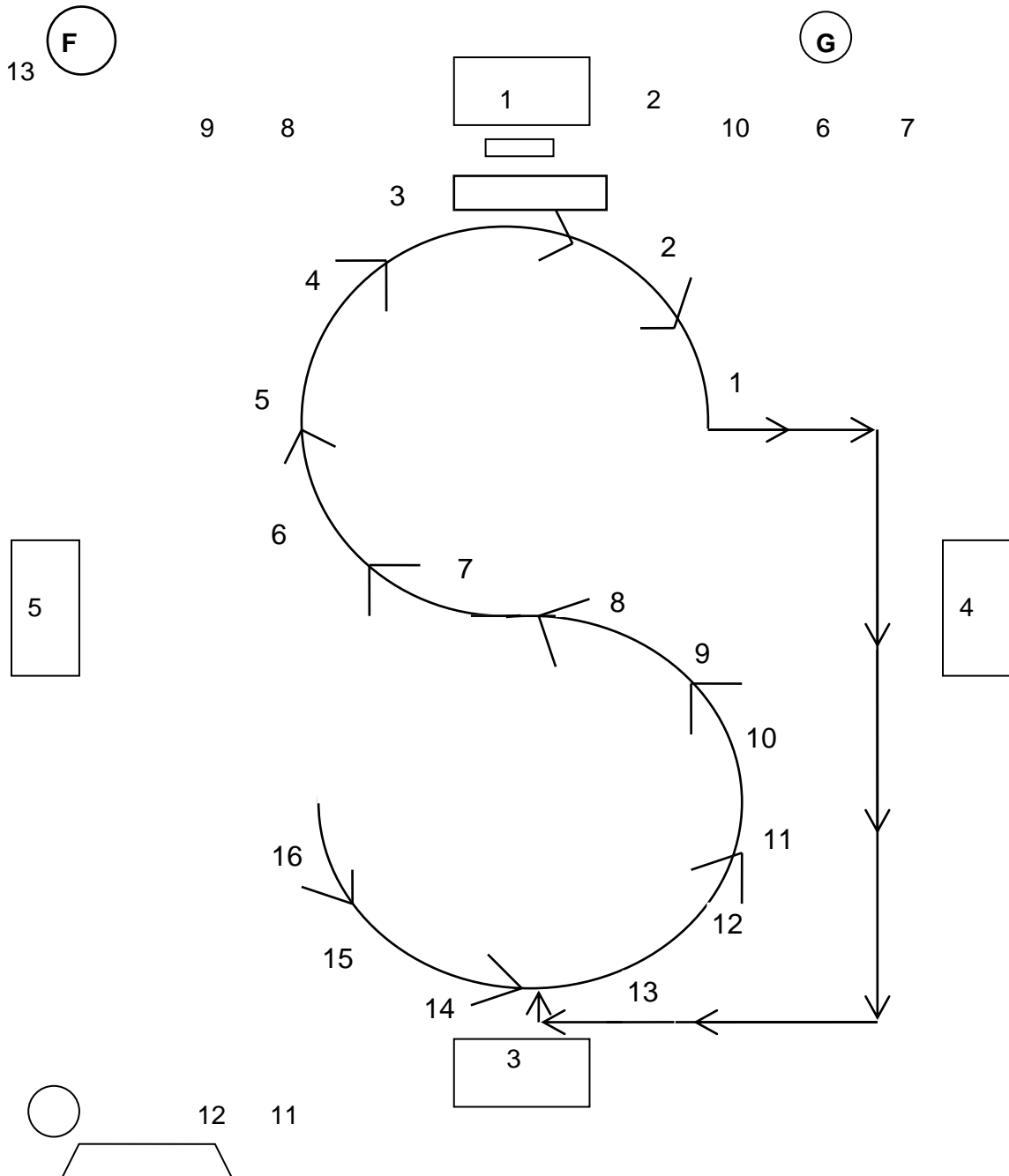


**President Honoured Royal Lady** – ‘A’ represents our **Aims** - to help all who need assistance; to relieve misery and to dry the tears of sorrow.





**DIAGRAM 12 - Pansy Drill**  
**COMPLETING THE LETTER 'S'**



*On completion of the S,*

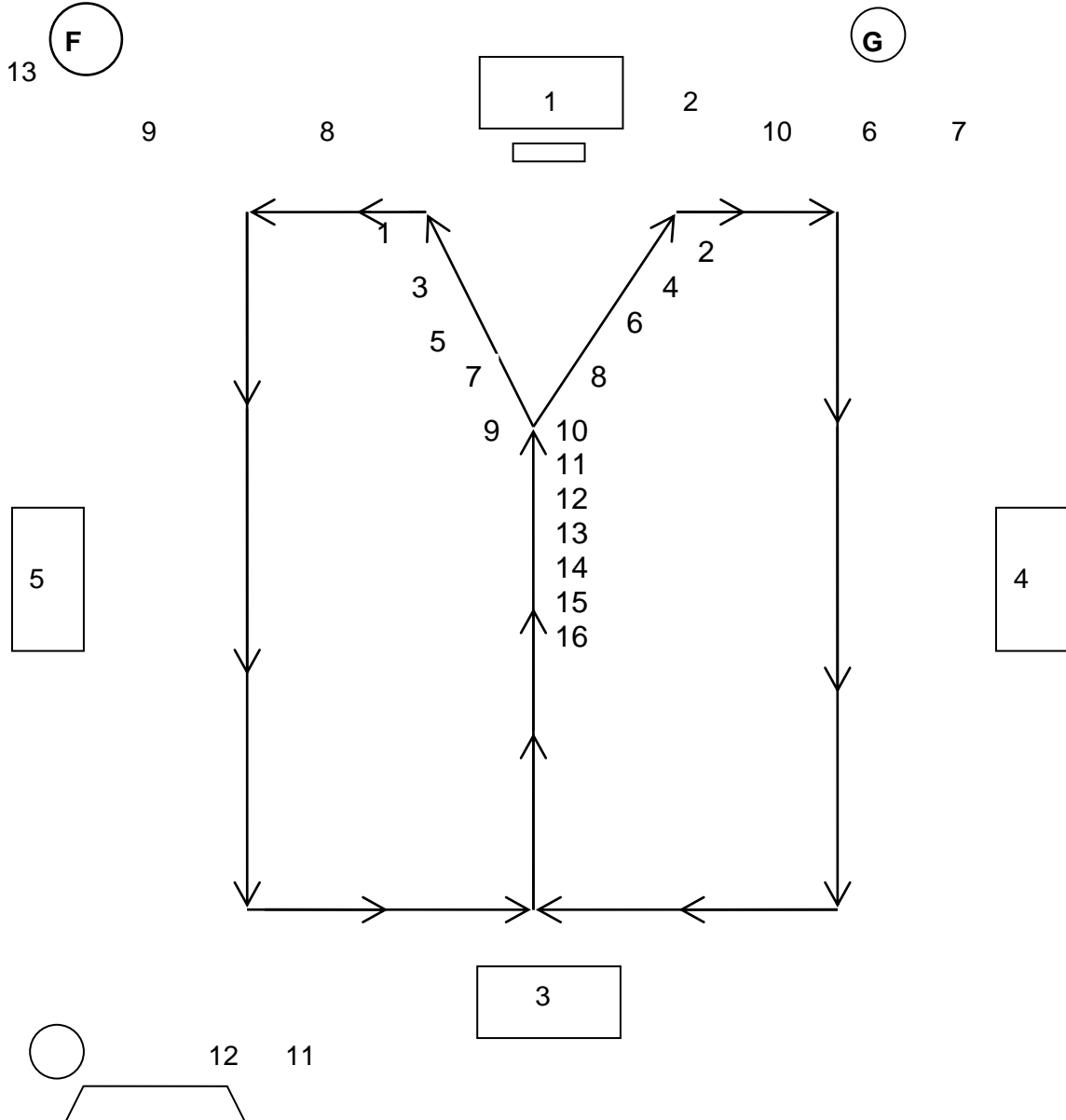
**President/Honoured Royal Lady** – ‘S’ is for **Service** and **Love**. May we replace all selfish pride and anger in our hearts with love, kindness and understanding.

*Team leaves ‘S’ formation in single file.*

### DIAGRAM 13 - Pansy Drill

#### FORMING THE LETTER 'Y'

*In forming the 'Y', Drill Team proceeds in single file to the center of the hall. Here they separate to form the top of the letter. Team leaves 'Y' formation, number 1 to the left and number 2 to the right.*



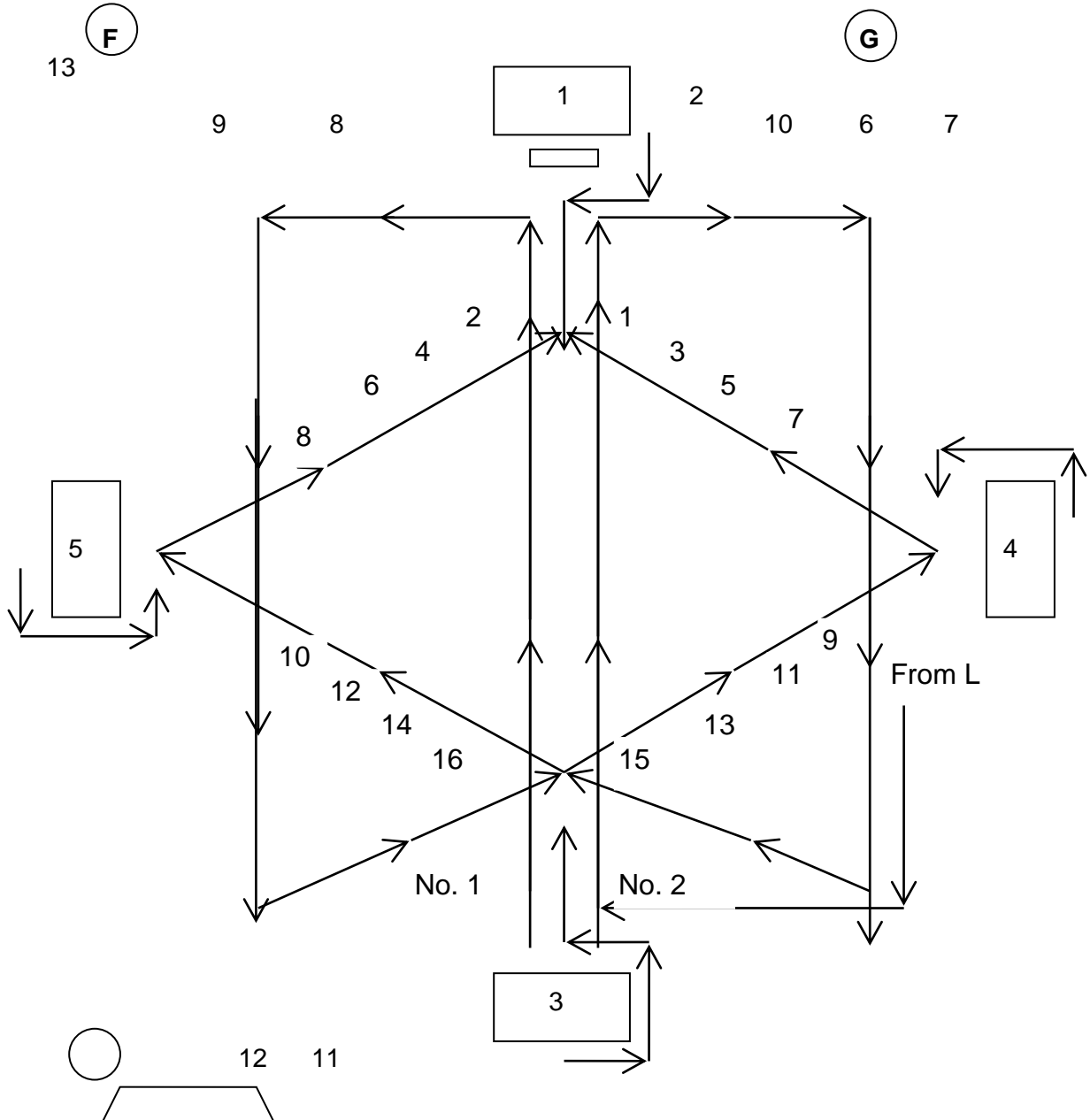
**President/Honoured Royal Lady - 'Y' is for the Young.** Special effort is made to bring song and laughter to their hearts and assistance to any youth in need.



**DIAGRAM 14 - FORMING DIAMOND WITH OFFICERS**

The Drill Team kneel (optional) to form the Diamond, 1st Vice President/Associate Royal Lady, 2nd Vice President/Loyal Lady and 3rd Vice President/Lecturing Lady take their several points of the Diamond, the Immediate Past President/Immediate Past Honoured Royal Lady takes the position at the head of the Diamond and the President/Honoured Royal Lady) remains at their position.

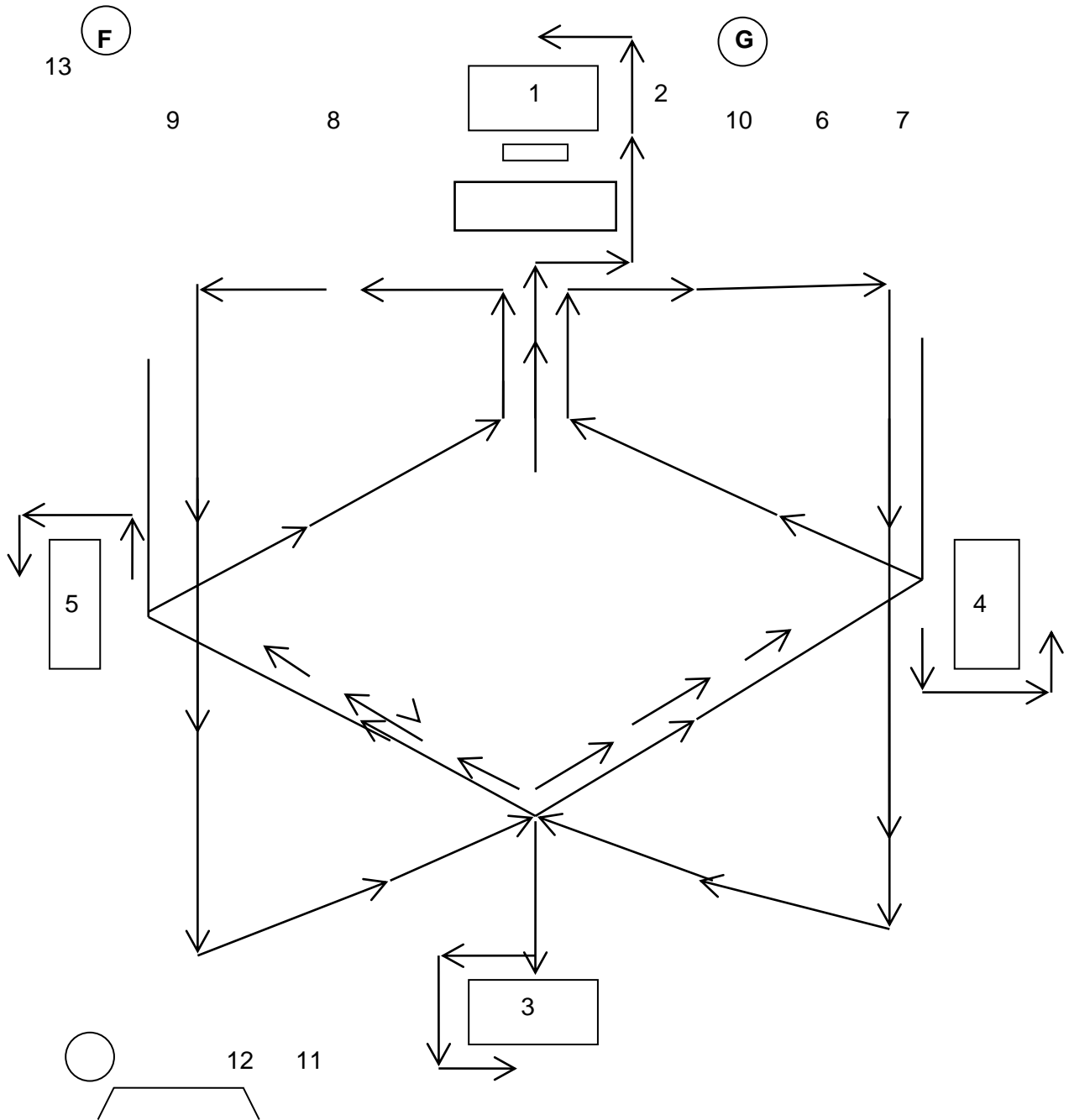
(Hands are not placed on shoulder in this formation).



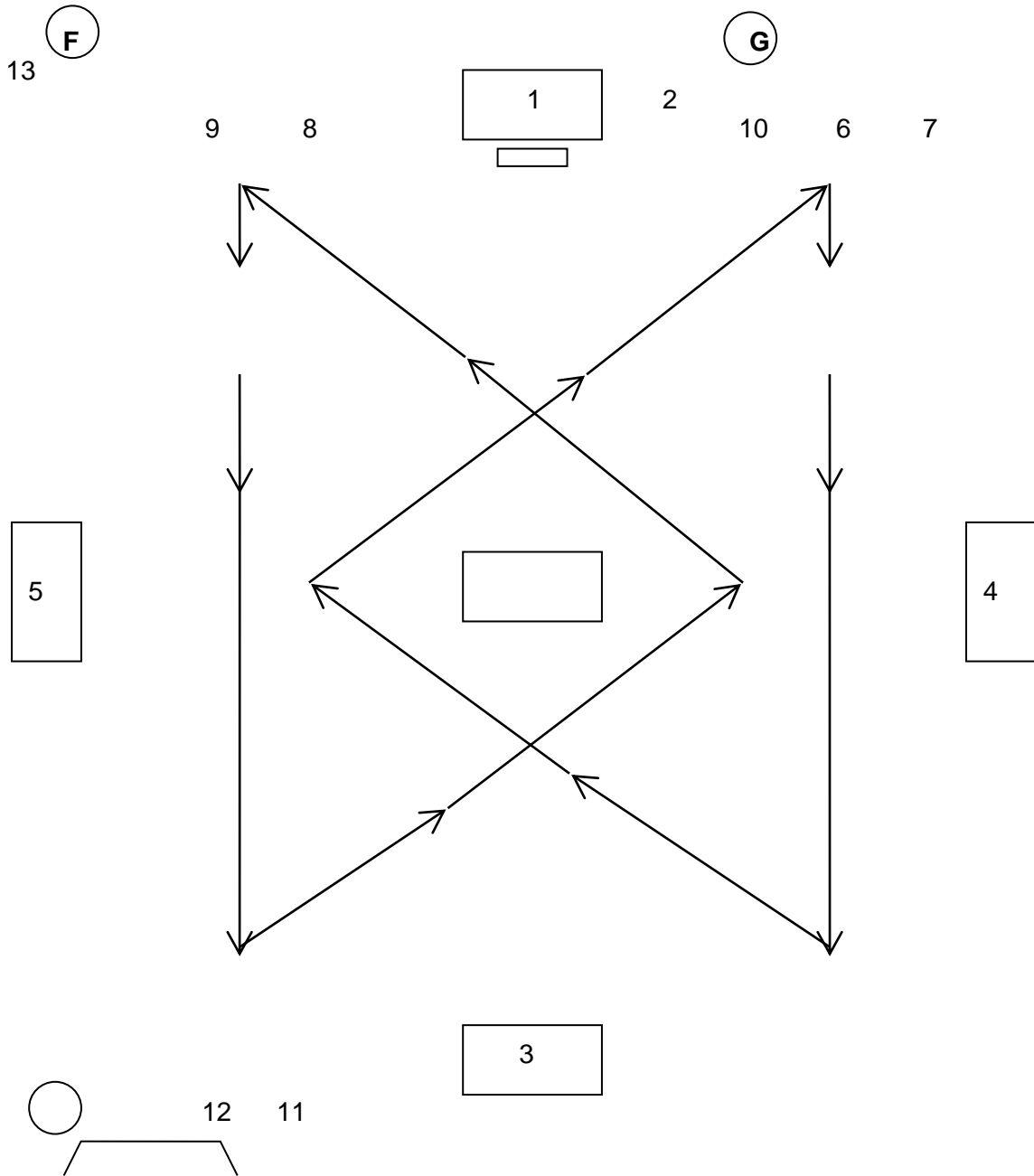
**HONOURED ROYAL LADY** - Then let the pansy thrive in the garden of our hearts and may this beautiful flower ever remind us that wherever it blooms, it signifies a better life and a happier world.

### DIAGRAM 15- TEAM AND DIRECTORS OFFICERS RETURNING TO PLACES

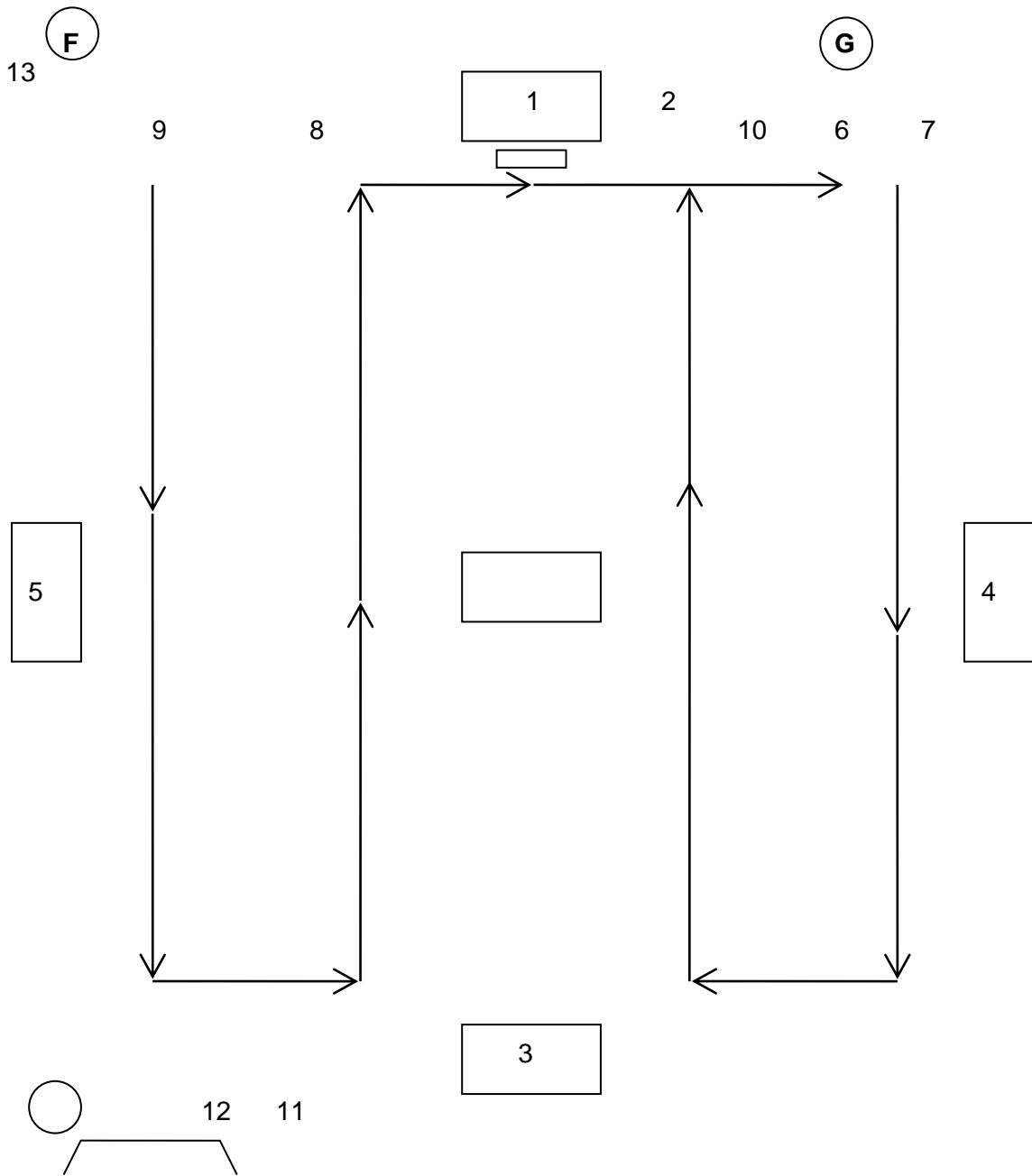
Officers go directly to their chairs. Do not cross over at top of Diamond.



**DIAGRAM 16 - FOUR PRINCIPLES DRILL  
OPENING FOUR PRINCIPLES DRILL**

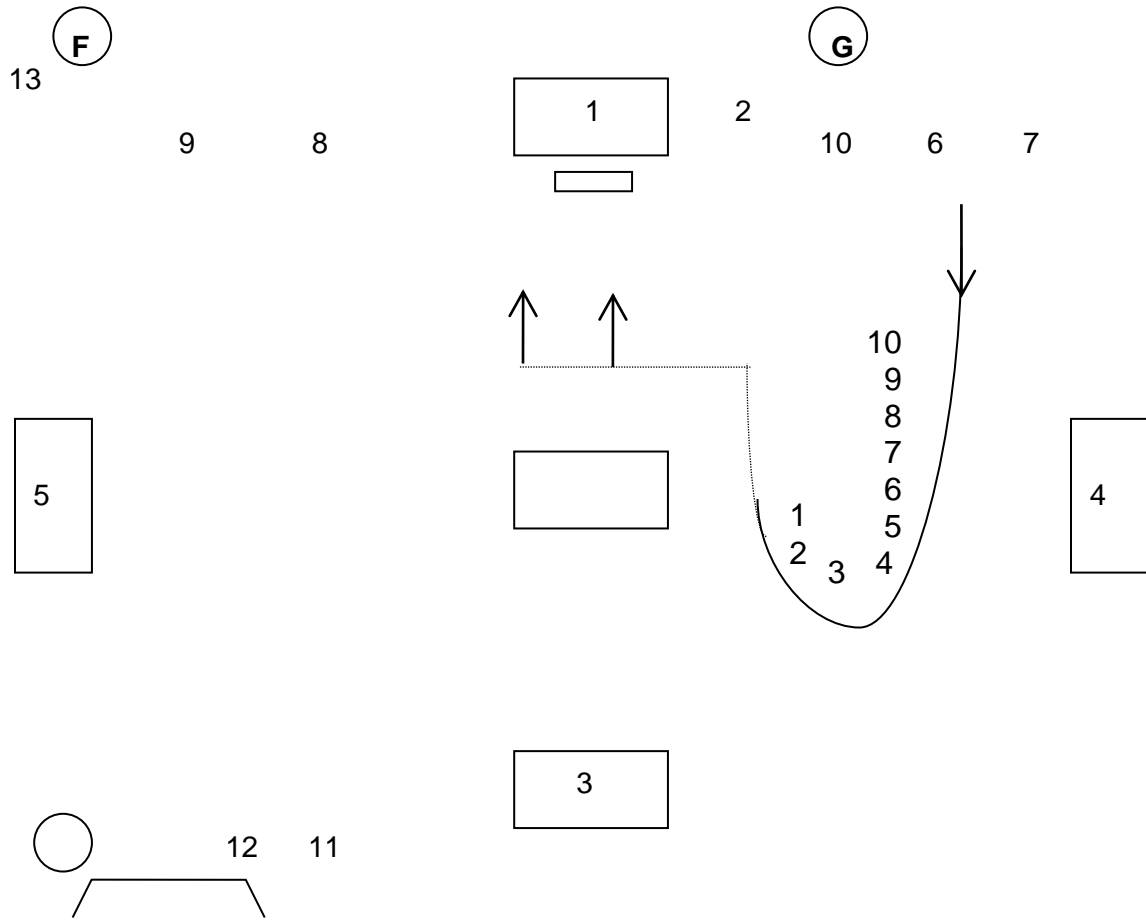


**DIAGRAM 17- OPENING FOUR PRINCIPLES DRILL**



**DIAGRAM 18 – Four Principles Drill**

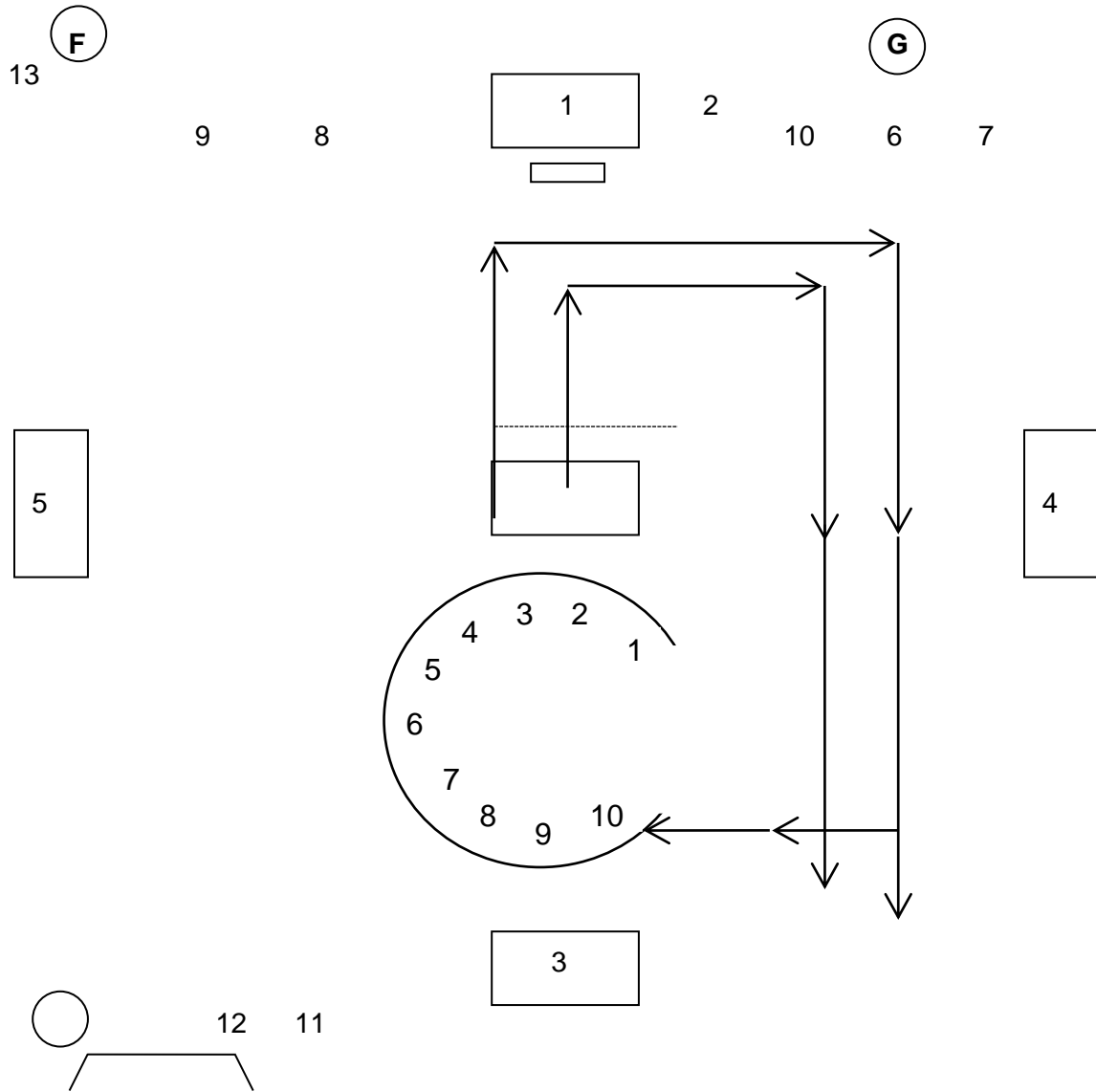
**FORMING THE LETTER ‘J’**



**2ND VICE PRESIDENT/LOYAL LADY –**  
 ‘J’ is for **Justice** - a standard of right,  
 The Democratic Principle strong.  
 With integrity we strive to be  
 Noble citizens as we go along.

**DIAGRAM 19 - Four Principles Drill**

**FORMING THE LETTER 'C'**



**1ST VICE PRESIDENT/ASSOCIATE ROYAL LADY –**

**'C'** is for **Charity** -

A Principle of caring.

A blessing of wealth untold.

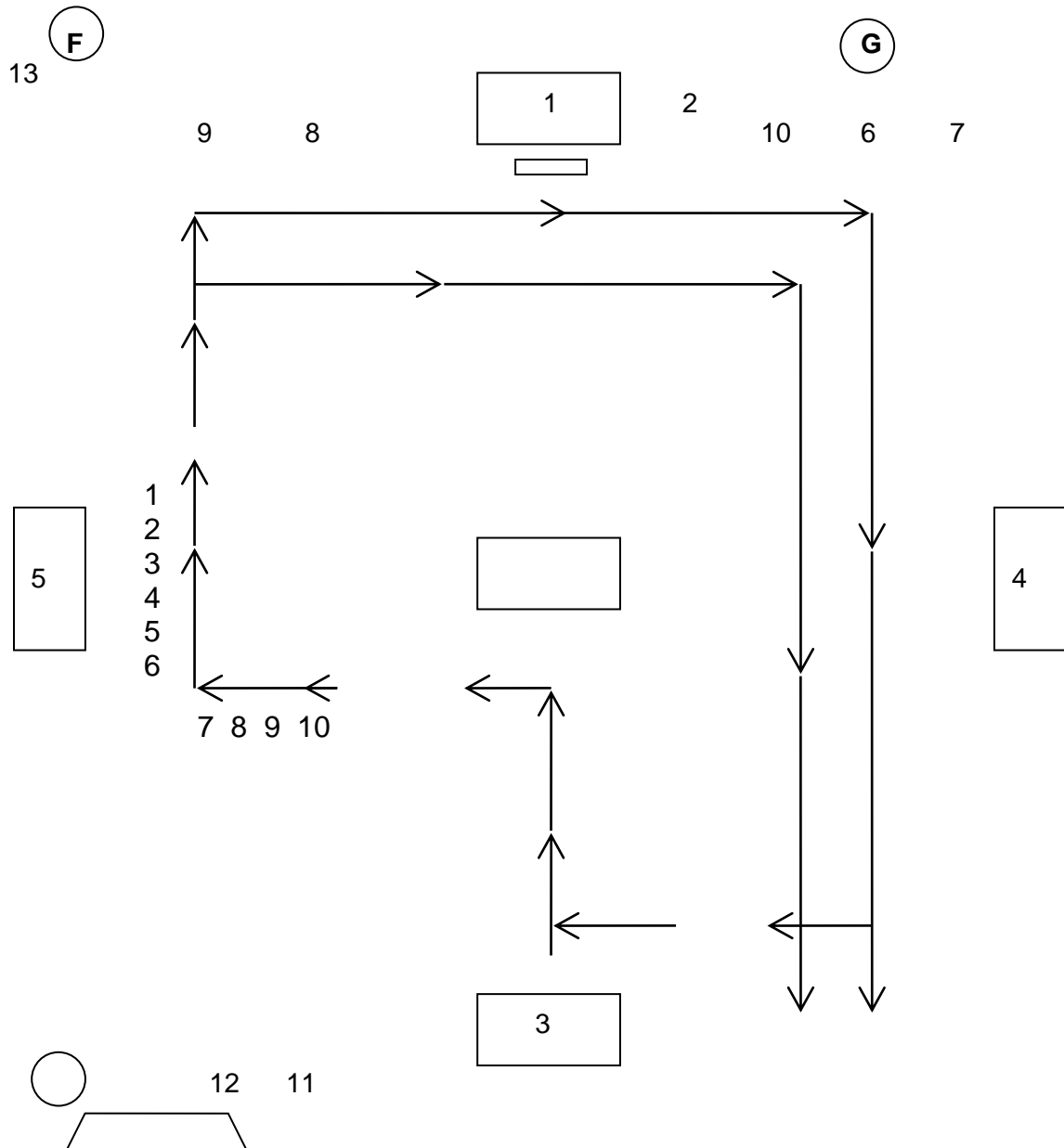
For those of our Society must always be sharing

Our beautiful rainbow of gold.



**DIAGRAM 21 - Four Principles Drill**

**FORMING THE LETTER 'L'**



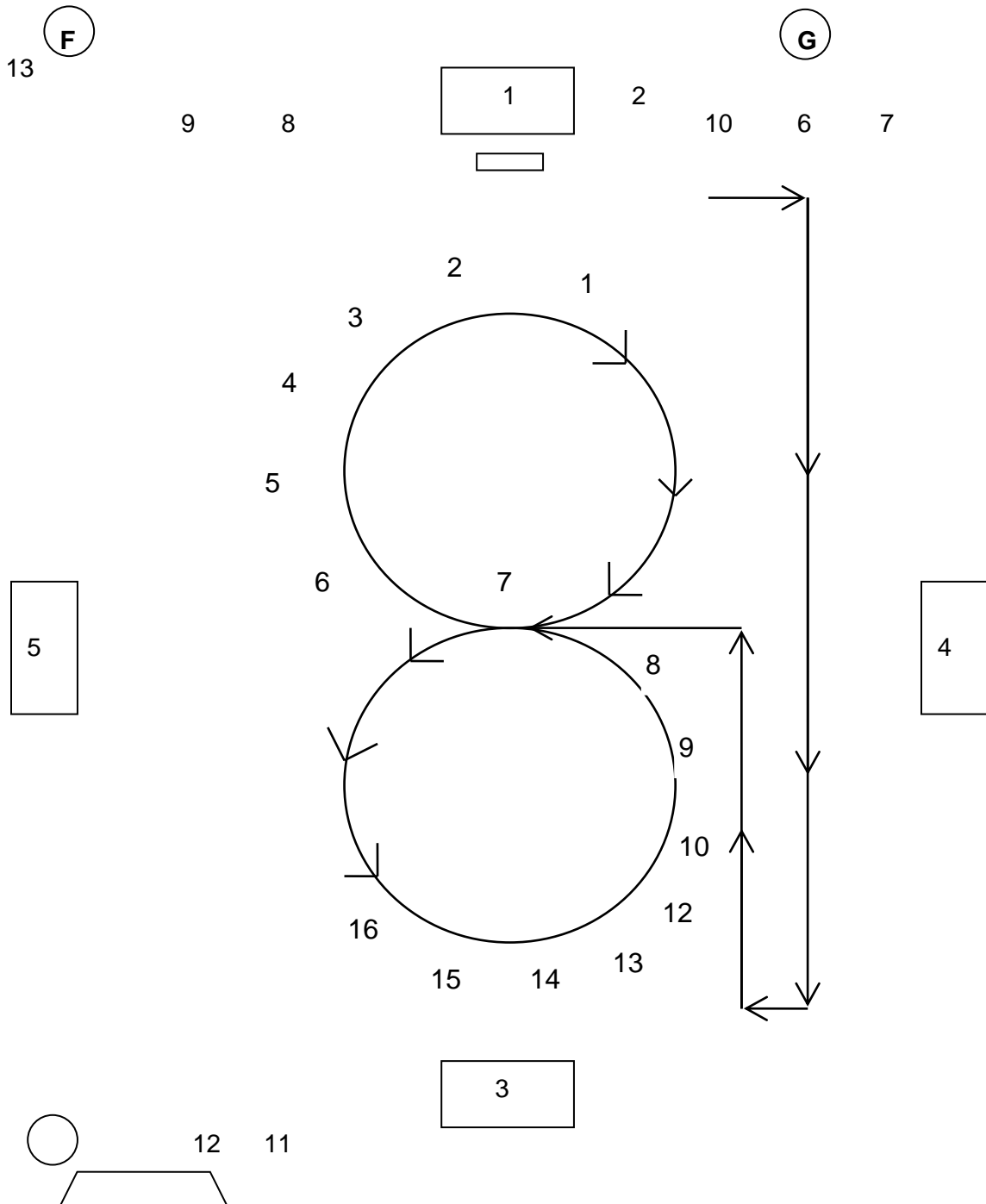
**3RD VICE PRESIDENT/LECTURING LADY –**

'L' is for **Love** - a Principle true.  
 A gift we should all be giving.  
 If we share our Love with someone new.  
 It brightens our way of living.



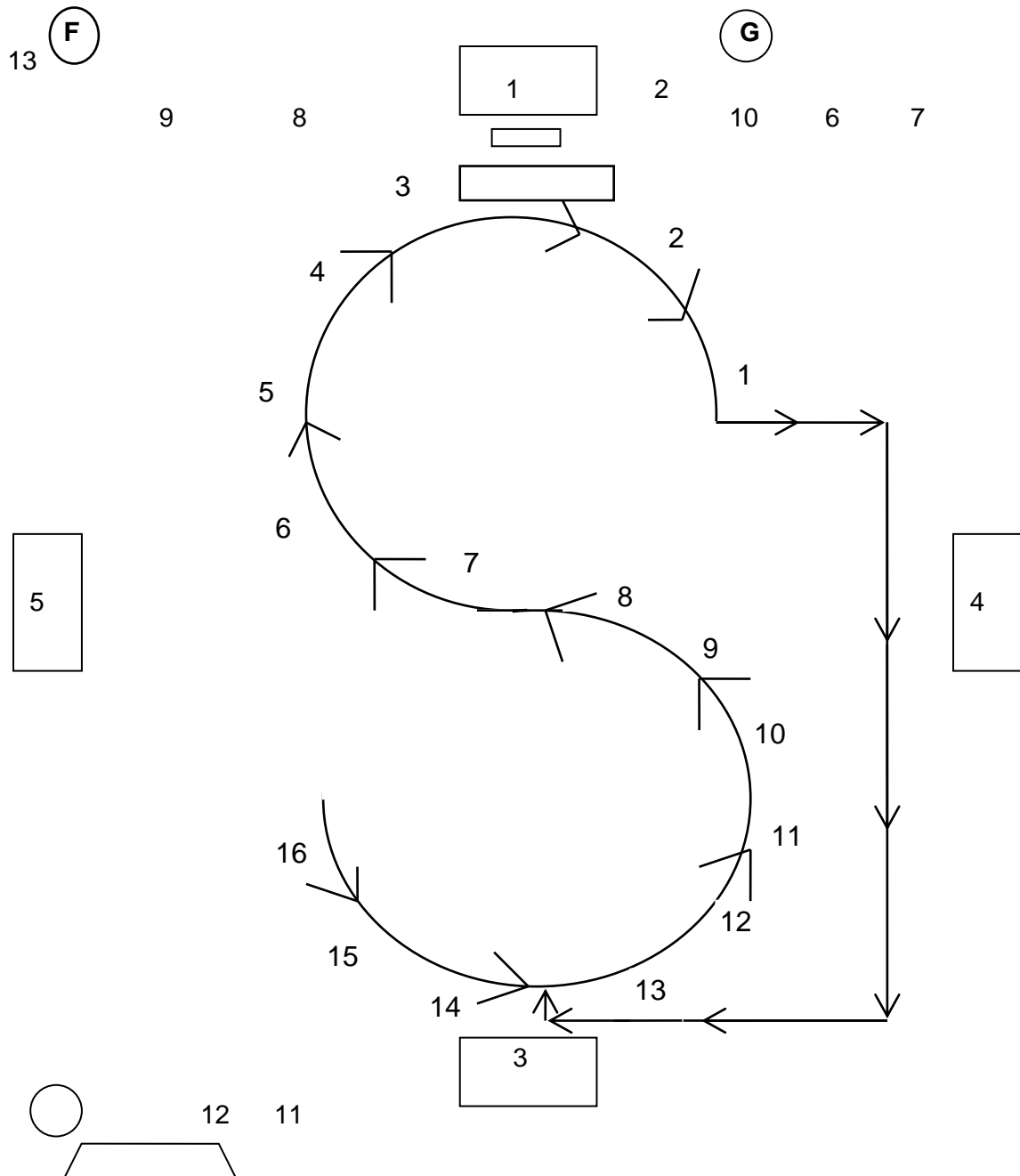
### DIAGRAM 22 - Four Principles Drill

#### FORMING THE LETTER 'S'



**DIAGRAM 23 - Four Principles Drill**

**COMPLETING THE LETTER 'S'**

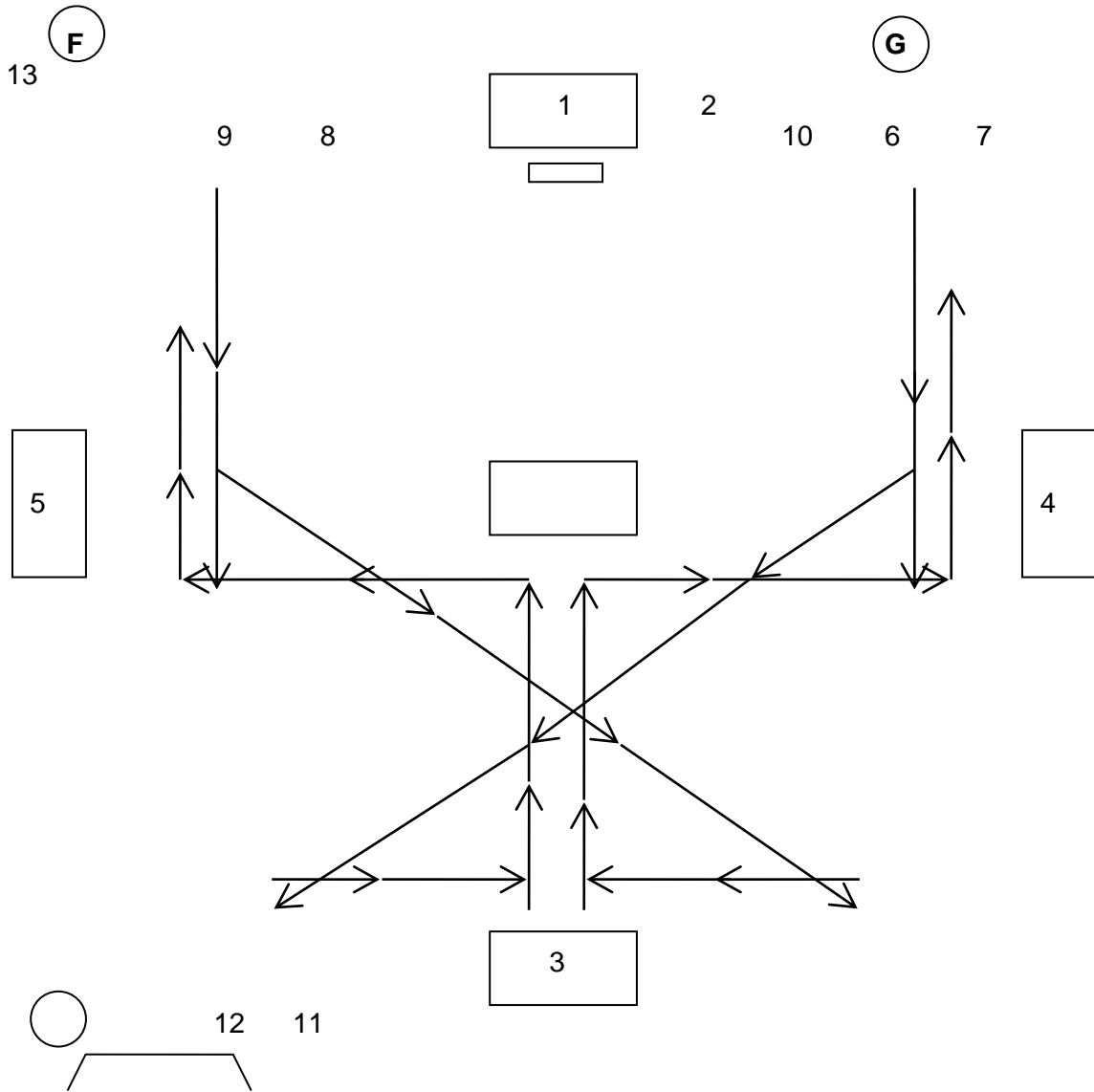


**PRESIDENT/HONOURED ROYAL LADY -**  
**'S'** is for **Service** - a Principle of dedication  
 A trait we all hold dear.  
 We strive to be true to our Obligation  
 And keep our Members near.



**DIAGRAM 25 - Four Principles Drill**

**TEAM RETURNING TO PLACES**



**PRESIDENT/HONOURED ROYAL LADY -**

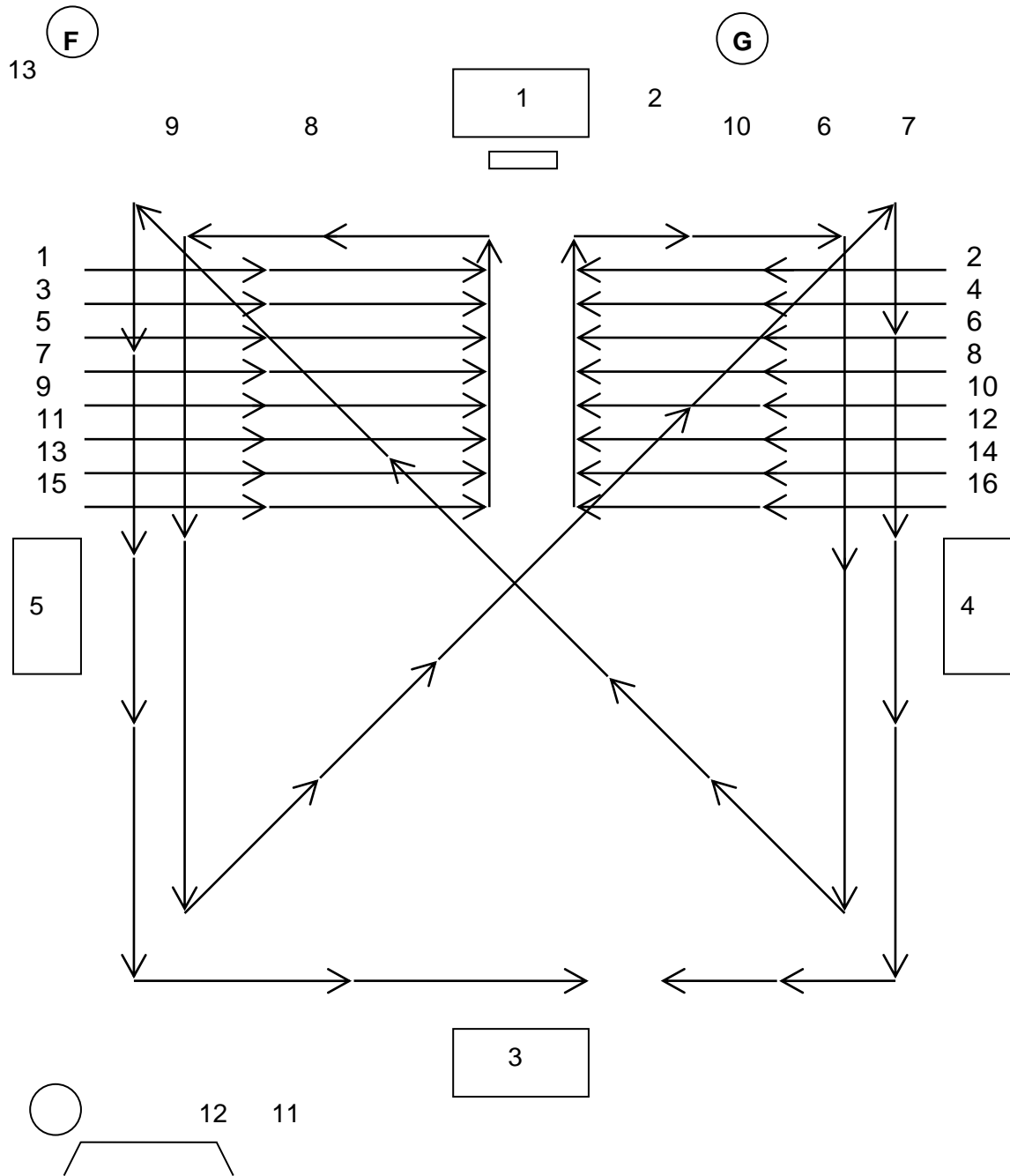
**Justice, Charity, Love and Service**

These Principles we choose.  
 Four Principles strong guiding us on  
 For a lifetime of caring.

Take the gift of life and love it;  
 Take your love and share it;  
 Give your laughter, smiles and tears;  
 Give your best, throughout the years;  
 Life is everything you make it.  
 Life is beautiful so cherish it.

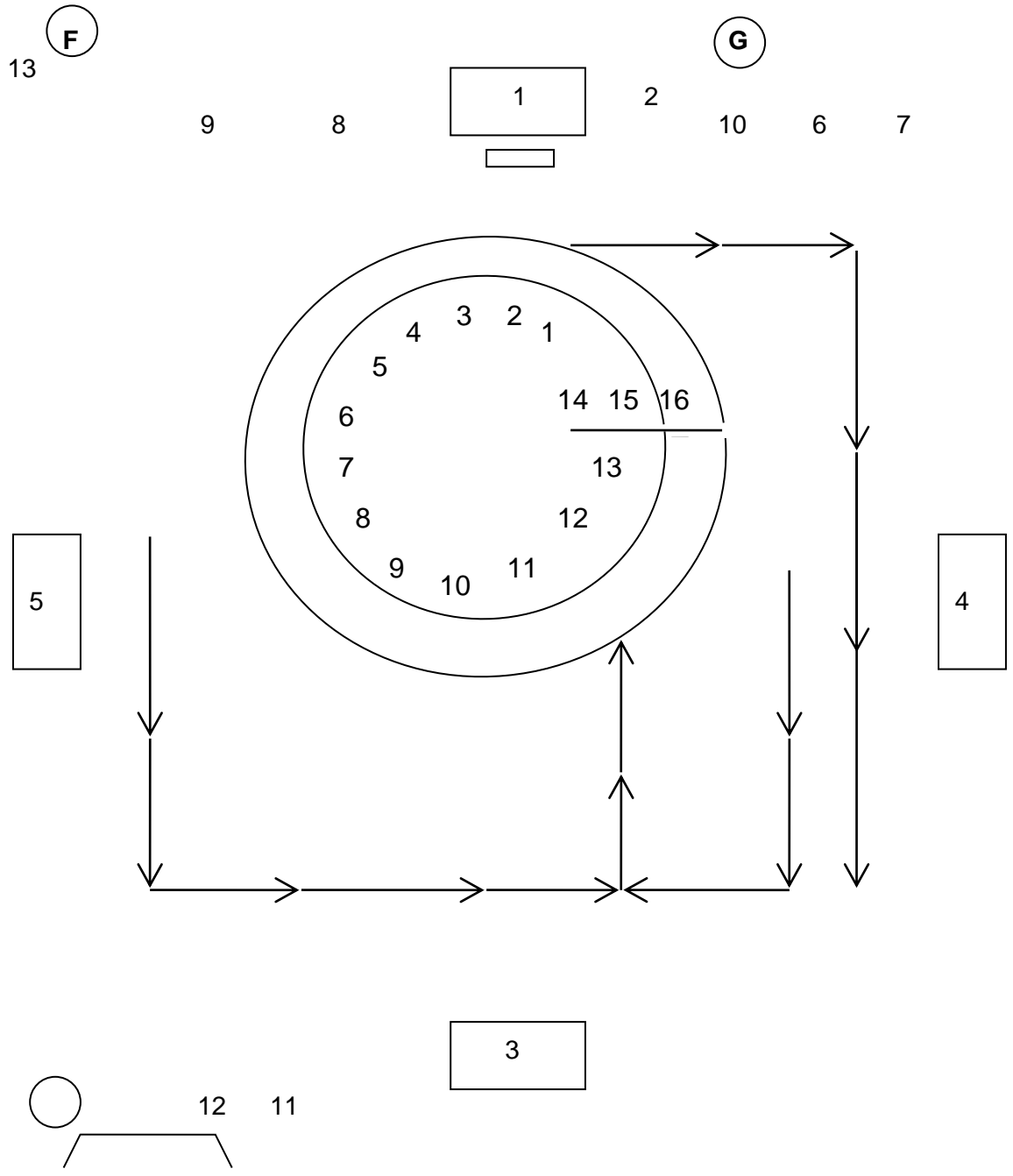
### GAVEL DRILL

#### DIAGRAM 26- OPENING GAVEL DRILL



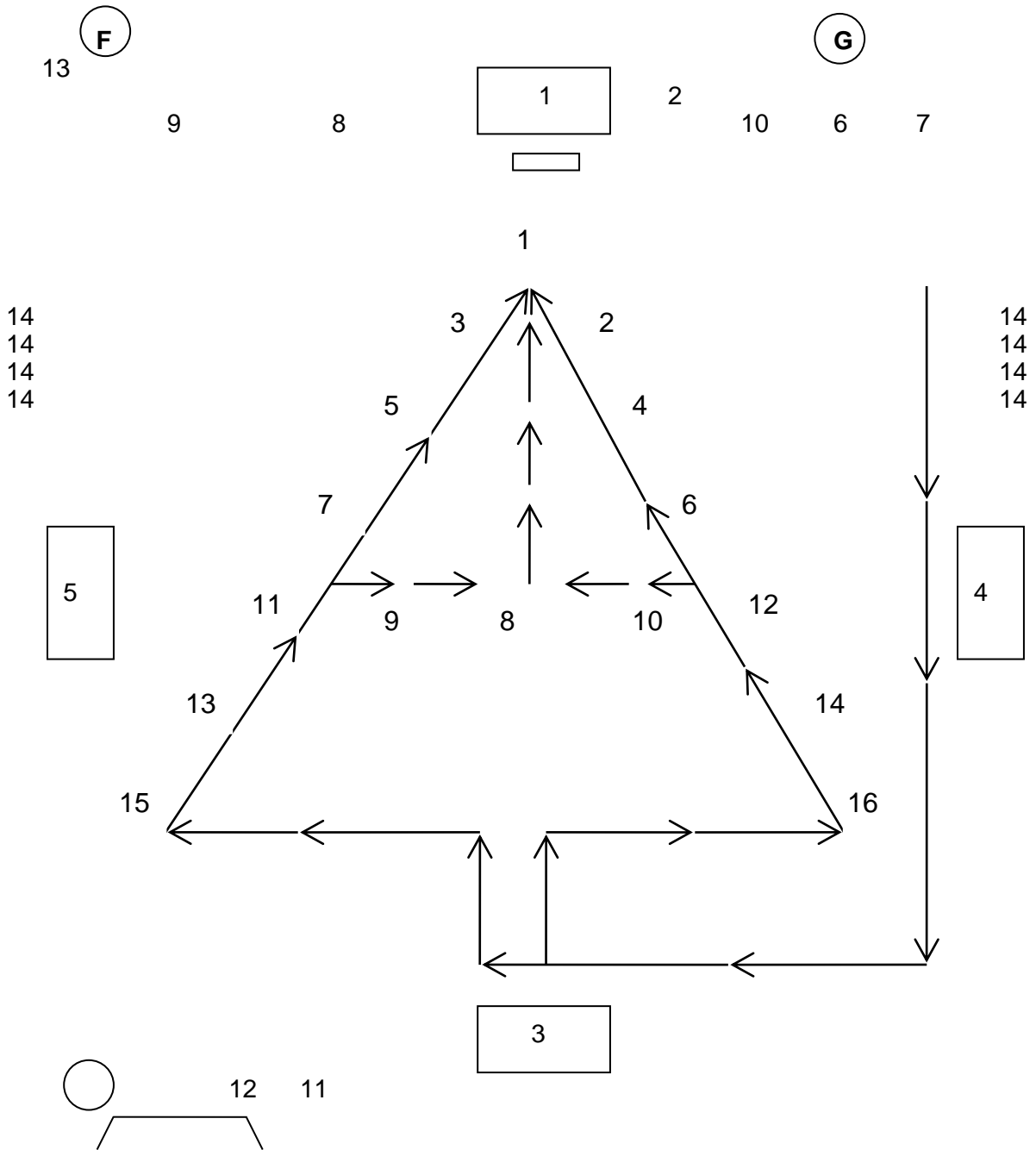
*PRESIDENT/HONOURED ROYAL LADY recites all charges.*

**DIAGRAM 27- Gavel Drill**  
**FORMING THE LETTER 'G'**



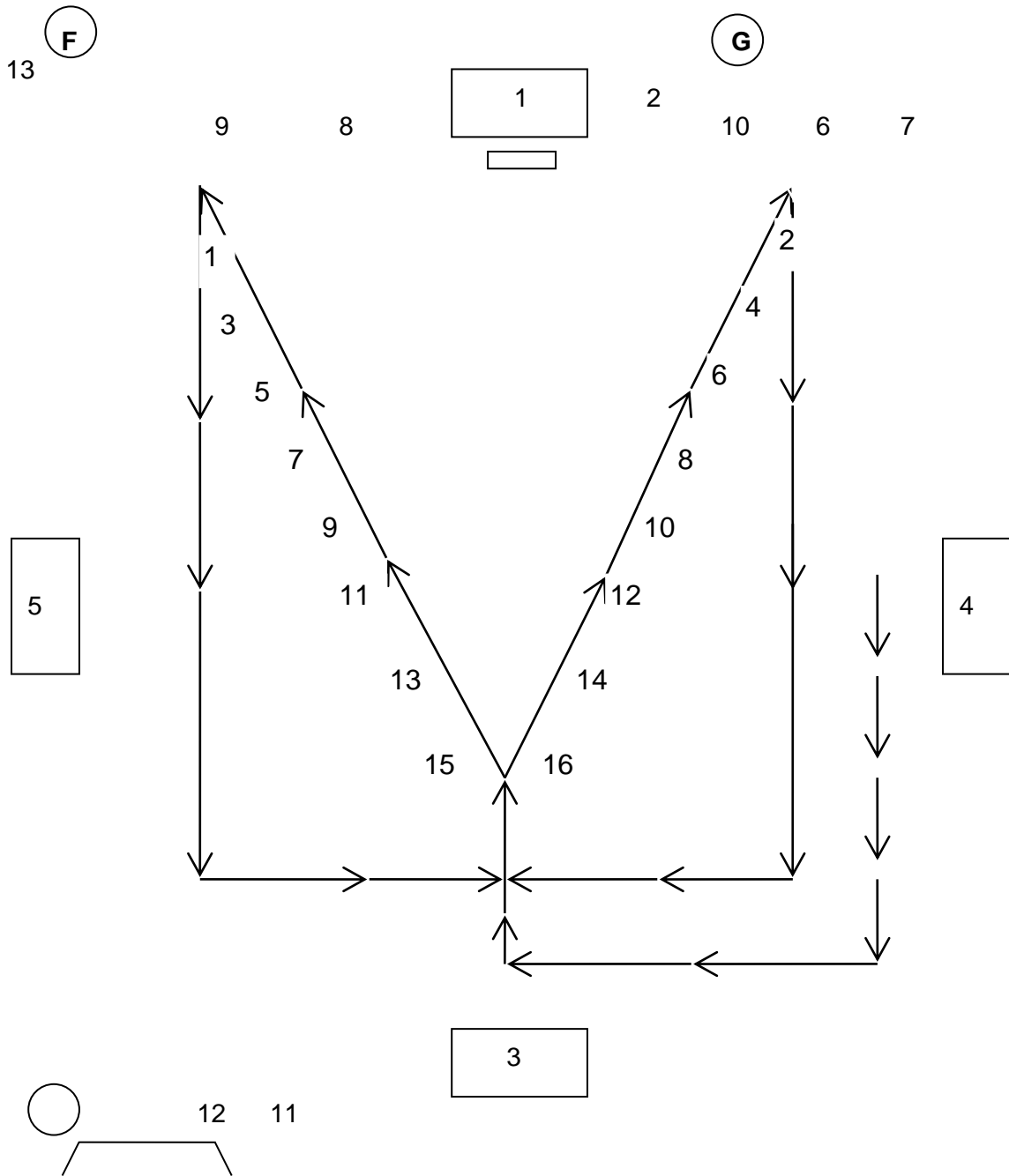
**PRESIDENT/HONOURED ROYAL LADY -**  
 'G' is for the **Gavel**, which we so proudly bring  
 With friendship, love and caring and every pleasant thing.  
 For "Good of the Order" the 'G' also stands,  
 And the fraternal joining of many willing hands.

**DIAGRAM 28 - Gavel Drill**  
**FORMING THE LETTER 'A'**



**PRESIDENT/HONOURED ROYAL LADY -**  
 'A' is for the **Association** that we share  
 With our members here and everywhere.  
 Across this broad land, from sea to sea  
 With Justice, Charity, Love and Service

**DIAGRAM 29 - Gavel Drill**  
**FORMING THE LETTER 'V'**

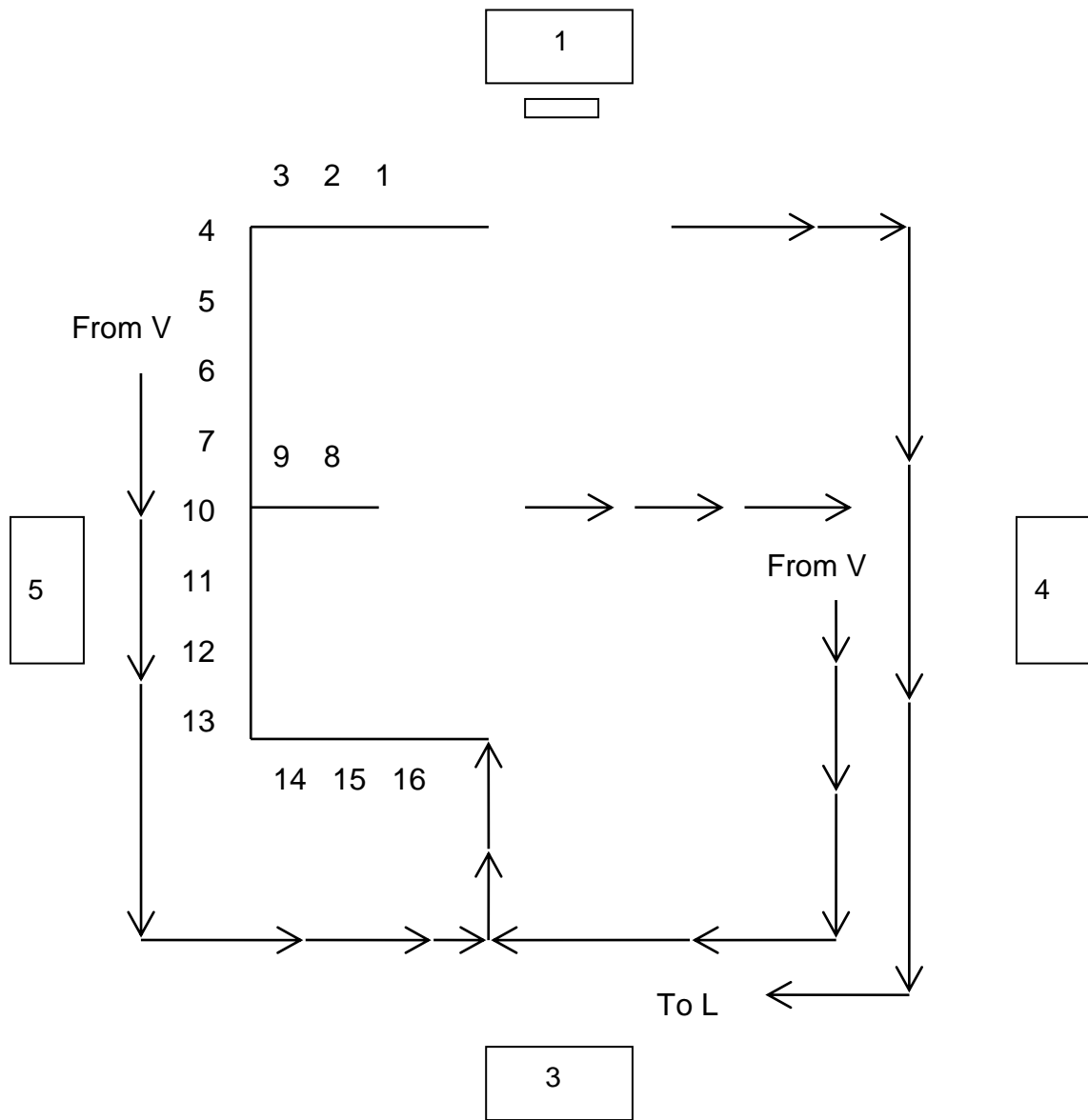


**PRESIDENT/HONOURED ROYAL LADY -**

'V' is for **Virtue**, ours to uphold.  
 With compassion and of caring, as our lives unfold.  
 To our noble Society may we always be true,  
 A promise we keep with all of you.

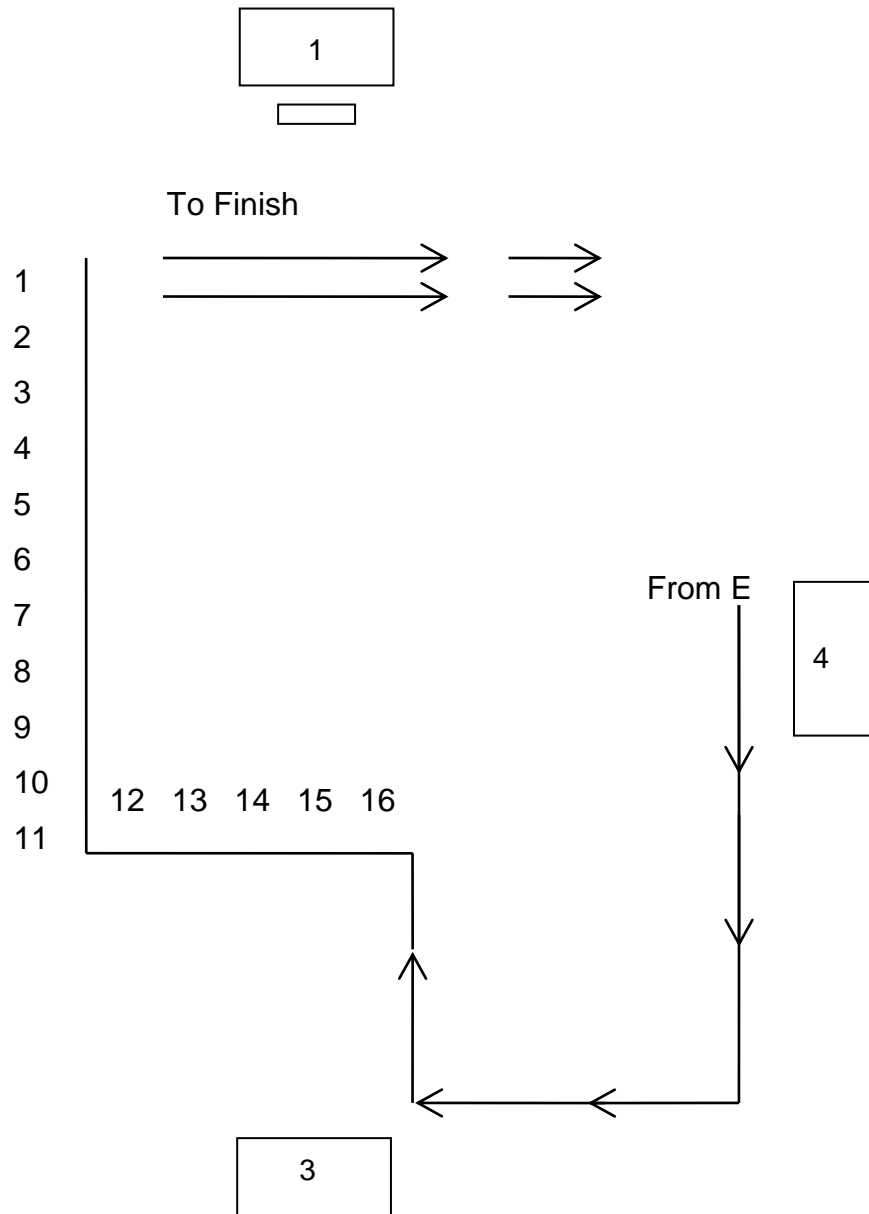


**DIAGRAM 30 - Gavel Drill**  
**FORMING THE LETTER 'E'**



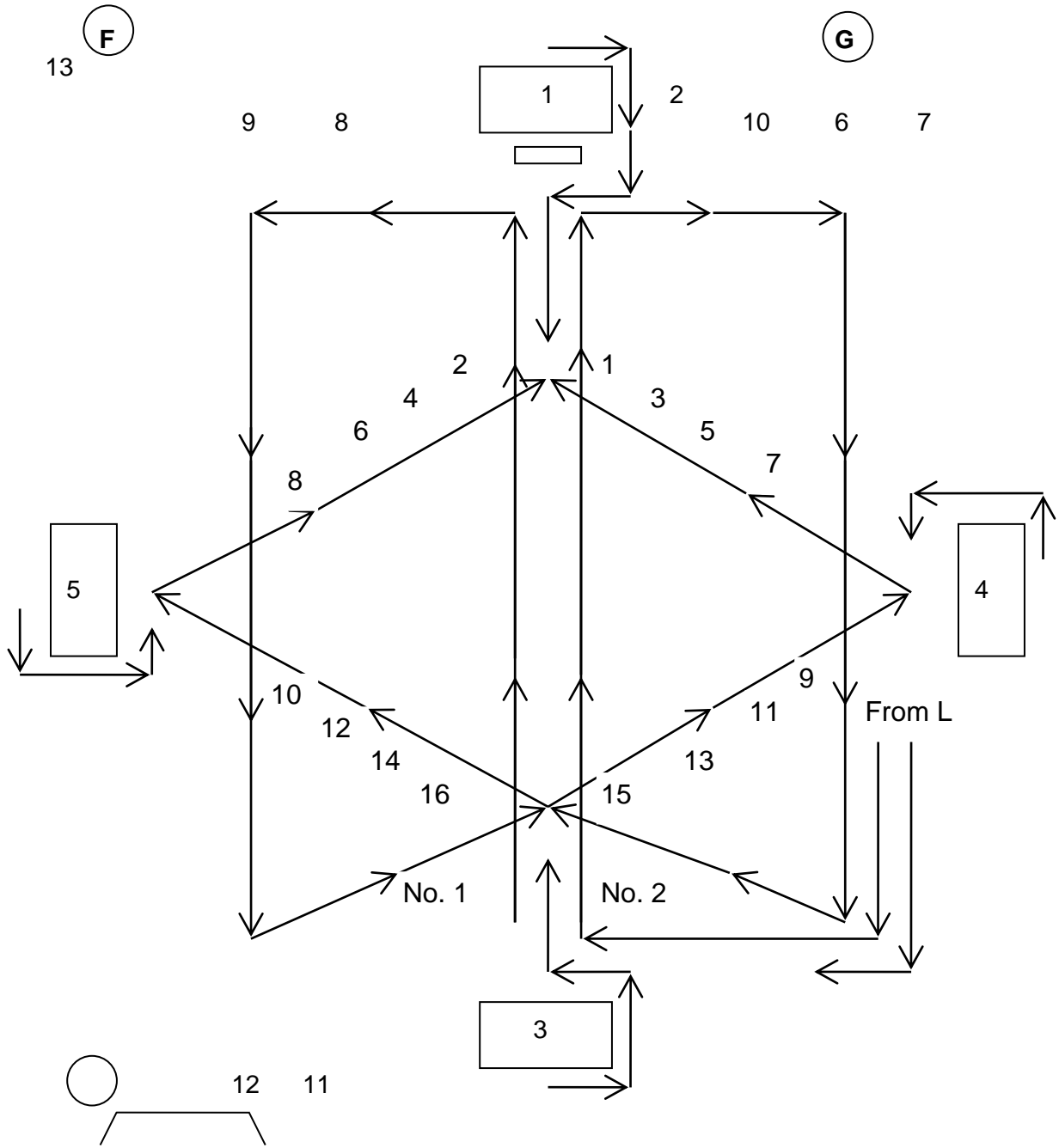
**PRESIDENT/HONOURED ROYAL LADY -**  
 'E' is for **Emblem**, the purple pansy fair.  
 With thoughts of love and happiness to mankind everywhere.  
 In the garden of our hearts let the pansy thrive,  
 And ever after through the world,  
 May love and peace survive.

**DIAGRAM 31- Gavel Drill**  
**FORMING THE LETTER 'L'**



**PRESIDENT/HONOURED ROYAL LADY -**  
'L' is for our **Lodge** of which we're proud  
Our meetings are friendly, we're part of the crowd.  
No matter the age, the colour, or creed,  
We willingly help all those in need.

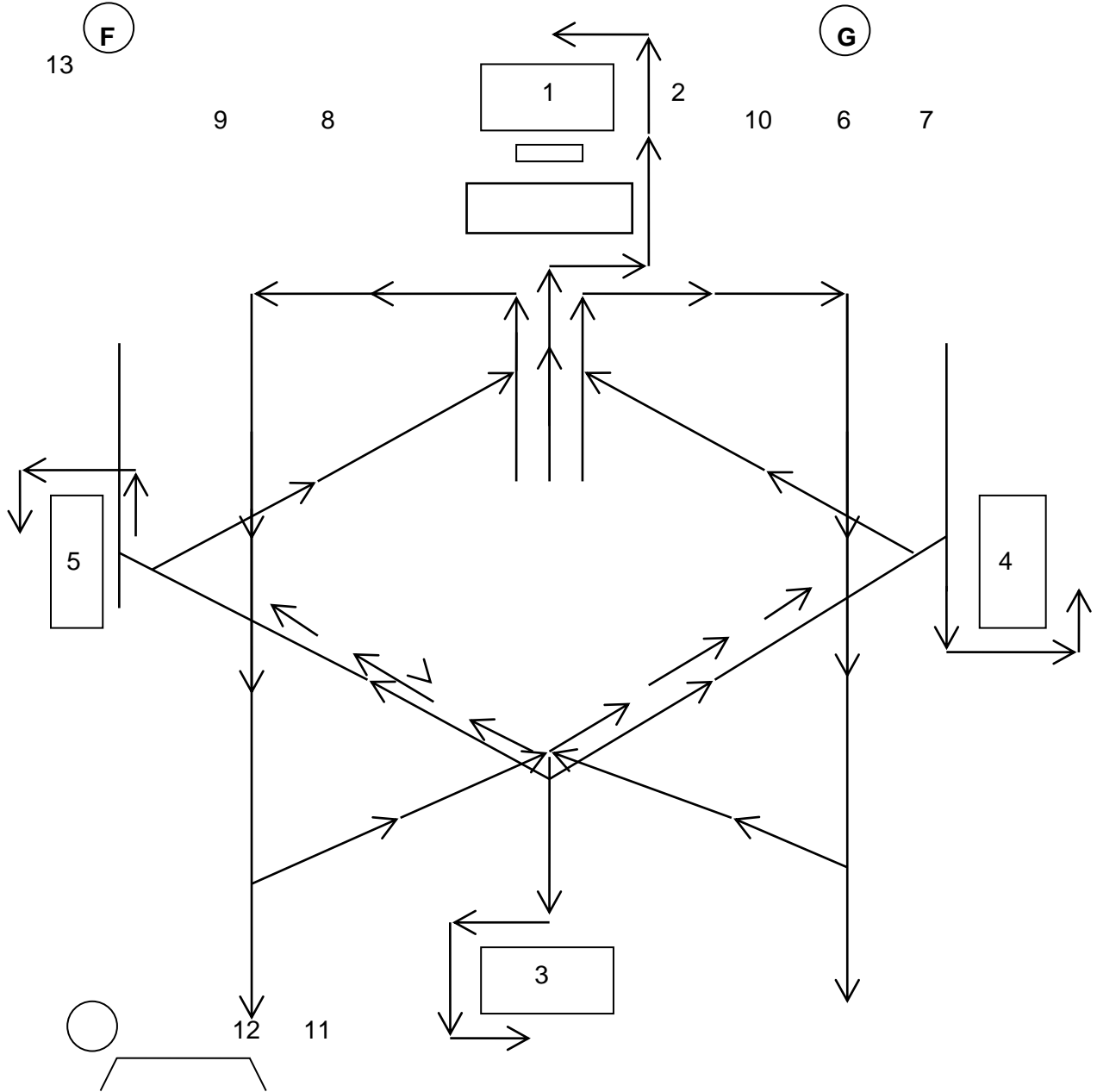
### DIAGRAM 32- Gavel Drill FORMING DIAMOND WITH OFFICERS



**DIAGRAM 33 - Gavel Drill**

**DRILL TEAM AND OFFICERS RETURNING TO PLACES**

Officers go directly to their chairs. Do not cross over at top of Diamond.



**LODGE PRESIDENT/HONOURED ROYAL LADY -**

Our Traveling Gavel means so much  
 From the gavel, to the friendly touch.  
 So use it, then take it along its way,  
 And bring it back to our meeting next Gavel Day.