

### **SECTION 3 – REGULAR MEETING-SHORT FORM**

1. Open Bible
2. Obligation
3. Declare Lodge open
4. Introduction of Visitors
5. Roll Call
6. Minutes
7. Treasurer's Report
8. Communications
9. Present Bills
10. Applications for Membership ( if applicable)
11. Reports
12. Report of Sunshine and Sickness
13. Sunshine March
14. Unfinished Business
15. New Business
16. Good of the Order
17. Closing Ceremony

*A small flag may be on the Centre Station in its upright position and shall remain until after the close of the meeting.*

*The Canadian flag is placed at the front of the room prior to the meeting to the right of the President/Honoured Royal Lady. The Royal Purple Lodge Flag is placed to the right of the Secretary and to the left of the Canadian Flag.*

*The Bible and pillow shall be placed on the Centre Station prior to the meeting.*

*All Officers and Drill Team are at their positions. The President/Honoured Royal Lady will call the meeting to order with one rap of the gavel. The Officers will put on their collars.*

**PRESIDENT/HONOURED ROYAL LADY- We will sing O CANADA and salute the Flag. (-O-O-O-)**

#### **"O CANADA"**

**O Canada! Our home and native land!  
True patriot love in all Thy sons command.  
With glowing hearts we see Thee rise,  
The True North strong and free!  
From far and wide, O Canada, we stand on guard for Thee.  
God keep our land glorious and free!  
O Canada, we stand on guard for Thee.  
O Canada, we stand on guard for Thee.**

*The Lodge is **not** seated after singing O CANADA.*

### 1. OPEN BIBLE

**PRESIDENT/HONOURED ROYAL LADY – Chaplain you will attend the Centre Station.**

*The Chaplain attends the Centre Station alone, and then leads in the Lord's Prayer.*

**DIAGRAM 2  
CHAPLAIN ATTENDING THE CENTRE STATION AND  
RETURNING TO POSITION USING SAME LINE OF MARCH**

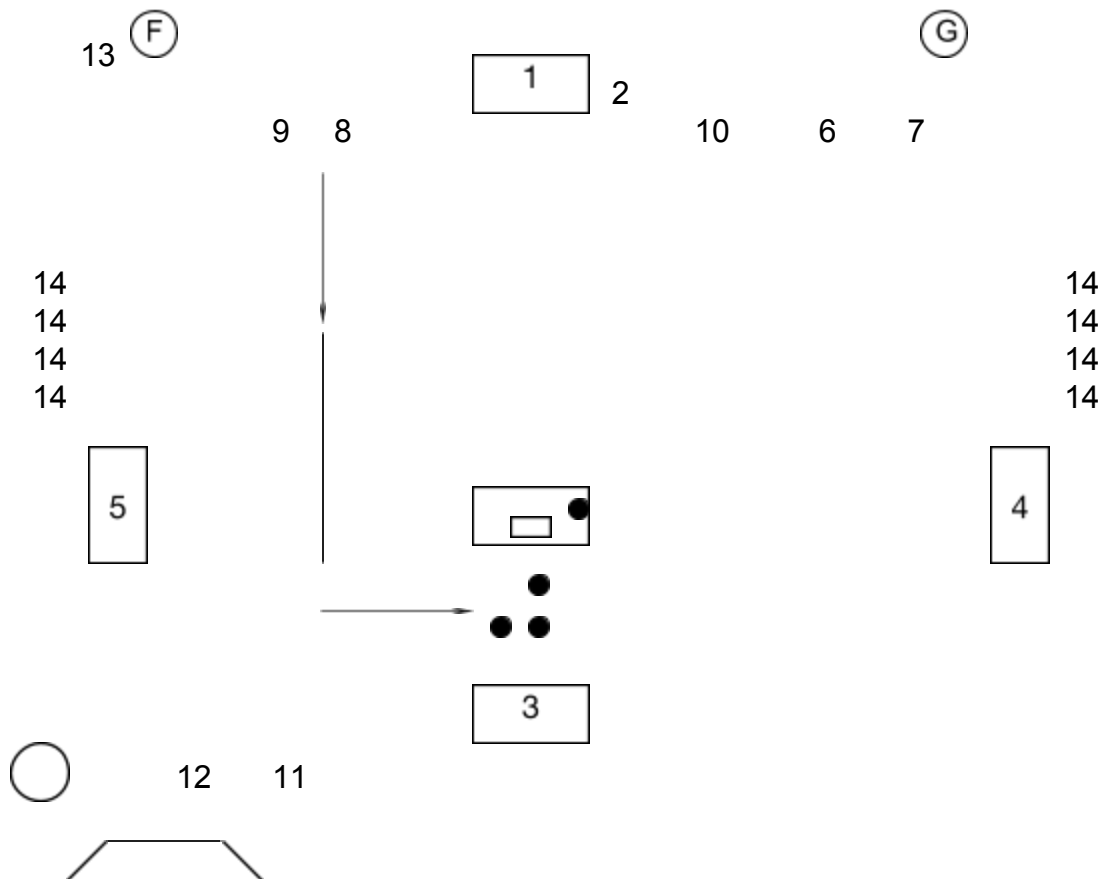

*The prayer for the Sick is to be given at the discretion of the President/Honoured Royal Lady before the Lord's Prayer if there are ill Member(s).*

### **PRAYER FOR THE SICK(Optional)**

**Oh God, may it please Thee, to bless our Member(s) \_\_\_\_\_ and to send Thy grace upon them. Restore them to health and strength if it be Thy gracious will. To the glory of Thy Holy name. Amen.**

## 2. OBLIGATION

**PRESIDENT/HONOURED ROYAL LADY – Members, we will repeat the Obligation, using the Obligation sign.**

I, \_\_\_\_\_, promise to be true to the laws of Canada, and to the laws of the Canadian Royal Purple. I will uphold and endeavor to promote the principles of JUSTICE, CHARITY, LOVE and SERVICE. All this I promise to fulfill to the best of my ability.

## 3. DECLARE LODGE OPEN

**PRESIDENT/HONOURED ROYAL LADY - I now proclaim \_\_\_\_\_ Lodge No. \_\_\_ of the Canadian Royal Purple, open for the transaction of such business as may properly come before it. (-O-)**

*After the President/Honoured Royal Lady has declared the Lodge open, any waiting Members take their places in the Lodge room. A Guard opens and closes the door for all Members.*

## 4. INTRODUCE VISITORS

**Optional:** Introductions may be omitted if no visiting dignitaries.

## 5. ROLL CALL

*The Secretary shall prepare the Members Register according to the Lodge Resource Manual.*

*An Officer of the Lodge shall sign the register in the Officer's column regardless of any other title they may have.*

*The Conductress will stand and answer "present" as Officers and Members rise in the response to the calling of their name or, as an option the Officers and Members may rise and answer "present" on their own behalf. If the Officer is absent, the Conductress or pro tem Officer will rise and say "absent, \_\_\_\_\_ pro tem."*

**PRESIDENT/HONOURED ROYAL LADY - Secretary, you will call the Roll of Officers and Members present from the Members' Register:**

**PRESIDENT/HONOURED ROYAL LADY - (-O-)**

**Note:** *Announcing the death of a Member (Charter Draping Ceremony- Attachment #1) shall be the first Order of Business after ROLL CALL. The President/Honoured Royal Lady, with the consent of the Members, may change the Order of Business for the Charter Draping Ceremony.*

*The Memorial Day Program shall be performed immediately after ROLL CALL (Attachment #2)*

## 6. READING OF THE MINUTES

**PRESIDENT/HONOURED ROYAL LADY–Secretary, you will read the minutes of our last regular, and if any, special meetings.**

*The Secretary will rise, give salute and address the President/Honoured Royal Lady before reading the minutes.*

**PRESIDENT/HONOURED ROYAL LADY - You have heard the reading of the minutes of our last regular (or special) meeting. Are there any errors or omissions? (Pause) If not, they stand approved.**

**PRESIDENT/HONOURED ROYAL LADY – Secretary they are approved as read (or corrected).**

*The Conductress hands the Minute Book to the President/Honoured Royal Lady for her signature and then hands it back to the Secretary*

**PRESIDENT/HONOURED ROYAL LADY - (-O-)**

## 7. TREASURER'S REPORT

**PRESIDENT/HONOURED ROYAL LADY - TREASURER, you will give your report.**

*The Treasurer will rise, salute and address the President/Honoured Royal Lady before giving their report. No motion is necessary to adopt this report.*

**PRESIDENT/HONOURED ROYAL LADY - (-O-)**

## 8. READING OF COMMUNICATIONS

**PRESIDENT/HONOURED ROYAL LADY - Secretary, you will read the communications.**

*Secretary rises, salutes and addresses the President/Honoured Royal Lady before reading the communications.*

**PRESIDENT/HONOURED ROYAL LADY - (-O-)**

## 9. PRESENT THE BILLS

**PRESIDENT/HONOURED ROYAL LADY - \_\_\_\_\_ Treasurer you will present the bills.**

*The Treasurer rises, salutes the President/Honoured Royal Lady and presents the bills.*

*After the bills are presented, the Treasurer or any Member of the Finance Committee may make a motion that the bills be paid.*

**PRESIDENT/HONOURED ROYAL LADY - (-O-)**

## 10. APPLICATION FOR MEMBERSHIP

*Determine if there are any applications for membership PRIOR to the meeting. If there are none, omit this and proceed to Reports.*

**PRESIDENT/HONOURED ROYAL LADY - \_\_\_\_\_ Secretary, do we have applications for Membership?**

**SECRETARY- President/Honoured Royal Lady), we do.(OR``Not at this time`` if none received).**

**PRESIDENT/HONOURED ROYAL LADY - Secretary, you will read all pertinent information.**

**PRESIDENT/HONOURED ROYAL LADY - (-O-)**

Short Form Initiation and Short Form Pansy Ceremony (see Attachments #3 and #4)

## 11. REPORTS

*The Lodge President/Honoured Royal Lady shall determine prior to the meeting the Officers. Standing Committees and Special Committee Reports to be heard and included on the agenda.*

**A) OFFICERS:**

*Officers report completion of specified duties assigned to their Office –i.e. CHAPLAIN reports sending a letter of condolence.– SECRETARY ,and TREASURER give semi-annual reports, etc.*

**PRESIDENT/HONOURED ROYAL LADY - We will hear the Officer's Reports.**

**B) STANDING COMMITTEES:**

*i.e.- Member Services, Finance, Judiciary, Charities*

**PRESIDENT/HONOURED ROYAL LADY - We will hear the Standing Committee Reports.**

**C) SPECIAL COMMITTEES:**

*If elections are being held, see Attachment 5; Installation - Attachment #6*

**PRESIDENT/HONOURED ROYAL LADY - We will hear the Special Committee Reports.**

**PRESIDENT/HONOURED ROYAL LADY - (-O-)**

## 12. REPORT OF SUNSHINE AND SICKNESS

**PRESIDENT/HONOURED ROYAL LADY - We will hear the report of the Sunshine Chairman.**

## 13. SUNSHINE MARCH

*If no Drill Team, two Officers take the Sunshine boxes, one to the President/Honoured Royal Lady and one to the Chaplain (and if positions filled, to the Historian and Pianist) using a direct line of march. They then proceed down each side of the room, collecting sunshine donations and meet at the 1st Vice President/Associate Royal Lady's station, proceeding directly to the Treasurer where they will deposit the Sunshine boxes*

### DIAGRAM 3

Two Officers, as chosen, march down each side of the room to pick up the Sunshine Donations and take the Sunshine boxes to the Treasurer

#### Sunshine March

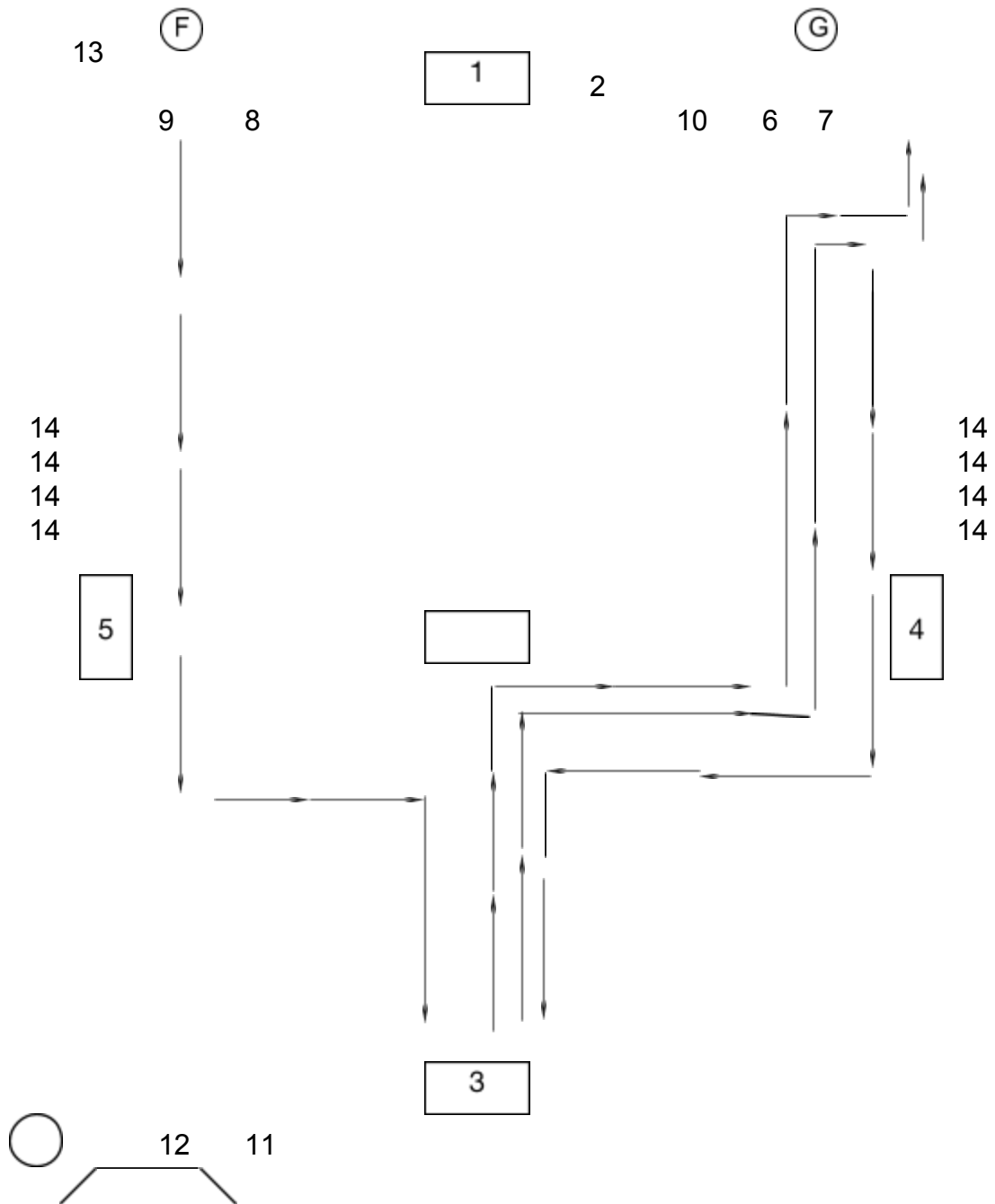

**They will turn and walk together down the side of the room, cross at the Loyal Lady's Station to the bottom of the Centre Station and return to their positions**

**DIAGRAM 4  
SUNSHINE MARCH**

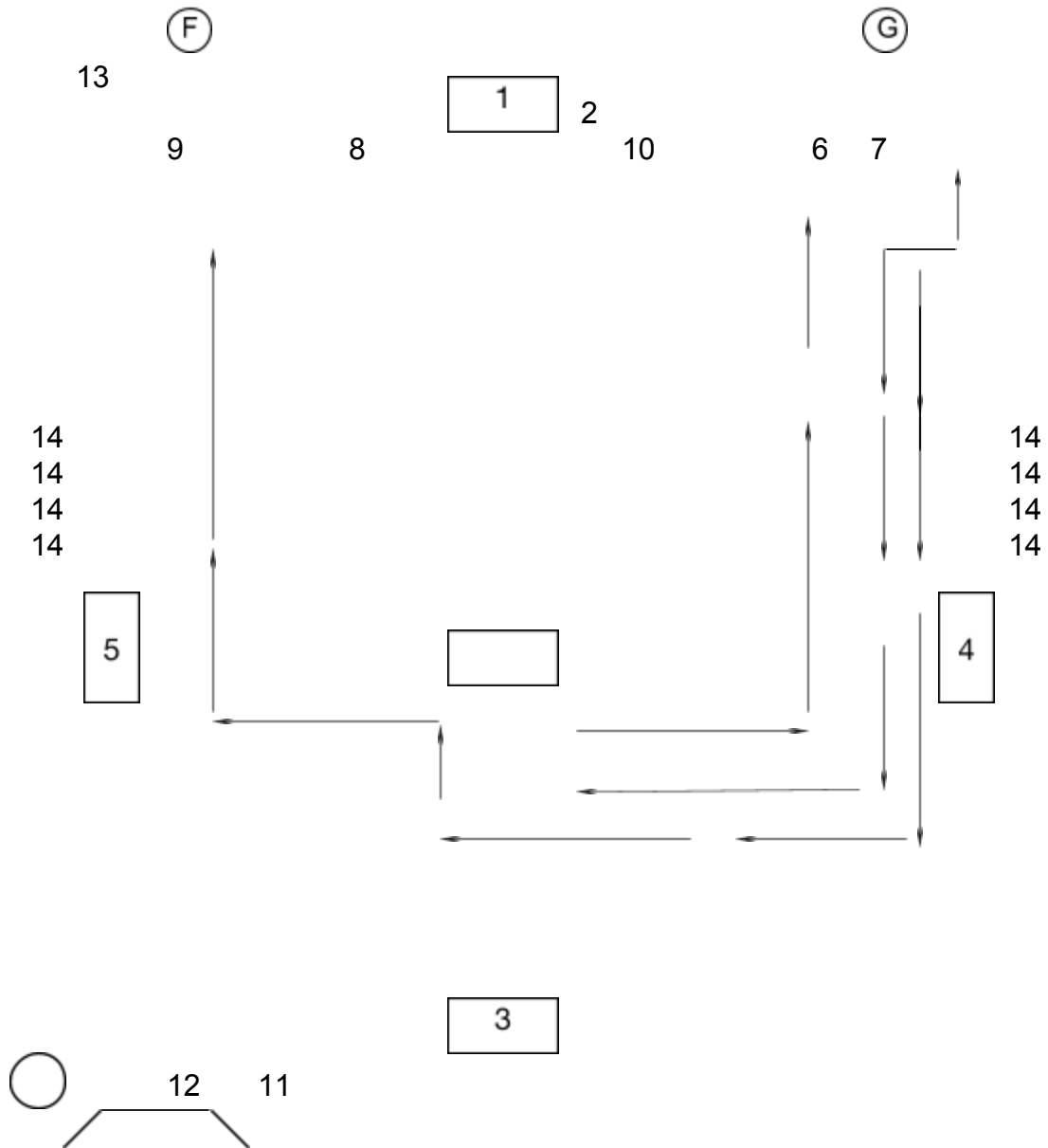

*Officers returning to their positions.*



#### **14. UNFINISHED BUSINESS**

*The President/Honoured Royal Lady shall present such unfinished business as is on the agenda and upon completion of such unfinished business shall say:*

**PRESIDENT/HONOURED ROYAL LADY - Secretary, do you know of any unfinished business?**

**SECRETARY - PRESIDENT/HONOURED ROYAL LADY, there is none (or report if there is).**

**PRESIDENT/HONOURED ROYAL LADY - (-O-)**

#### **15. NEW BUSINESS**

*The President/Honoured Royal Lady shall present such new business as on the agenda.*

**PRESIDENT/HONOURED ROYAL LADY - Is there any further New Business?**

**PRESIDENT/HONOURED ROYAL LADY - (-O-)**

#### **16. GOOD OF THE ORDER**

*i.e. Expressions of thanks, presentations, guests invited to speak.*

**PRESIDENT/HONOURED ROYAL LADY - (-O-)**

#### **17. CLOSING CEREMONY**

**PRESIDENT/HONOURED ROYAL LADY - Officers and Members, do you know of any business neglected or left undone?**

**1ST VICE PRESIDENT/ASSOCIATE ROYAL LADY - Lodge President/Honoured Royal Lady the work is finished.**

**PRESIDENT/HONOURED ROYAL LADY - Officers and Members form the Diamond. (-O-O-O-). DIAGRAM 9**

*After the Members have formed the Diamond, the four Chair Officers shall step out of their respective stations to form the points. After forming the Diamond, all turn in, in unison, join hands and repeat the Mispah Benediction. All hands remain clasped until after the singing of the Closing Ode.*

*In the absence of a Drill Team, the Conductress and Chaplain shall lead in forming the Diamond.*

## MISPAH BENEDICTION

May the Lord watch between me and Thee, while we are absent, one from the other.

### CLOSING ODE

God be with you till we meet again,  
By His counsel guide, uphold Thee,  
With His sheep securely fold Thee,  
God be with you till we meet again.

**DIAGRAM 5  
FORMING THE DIAMOND**

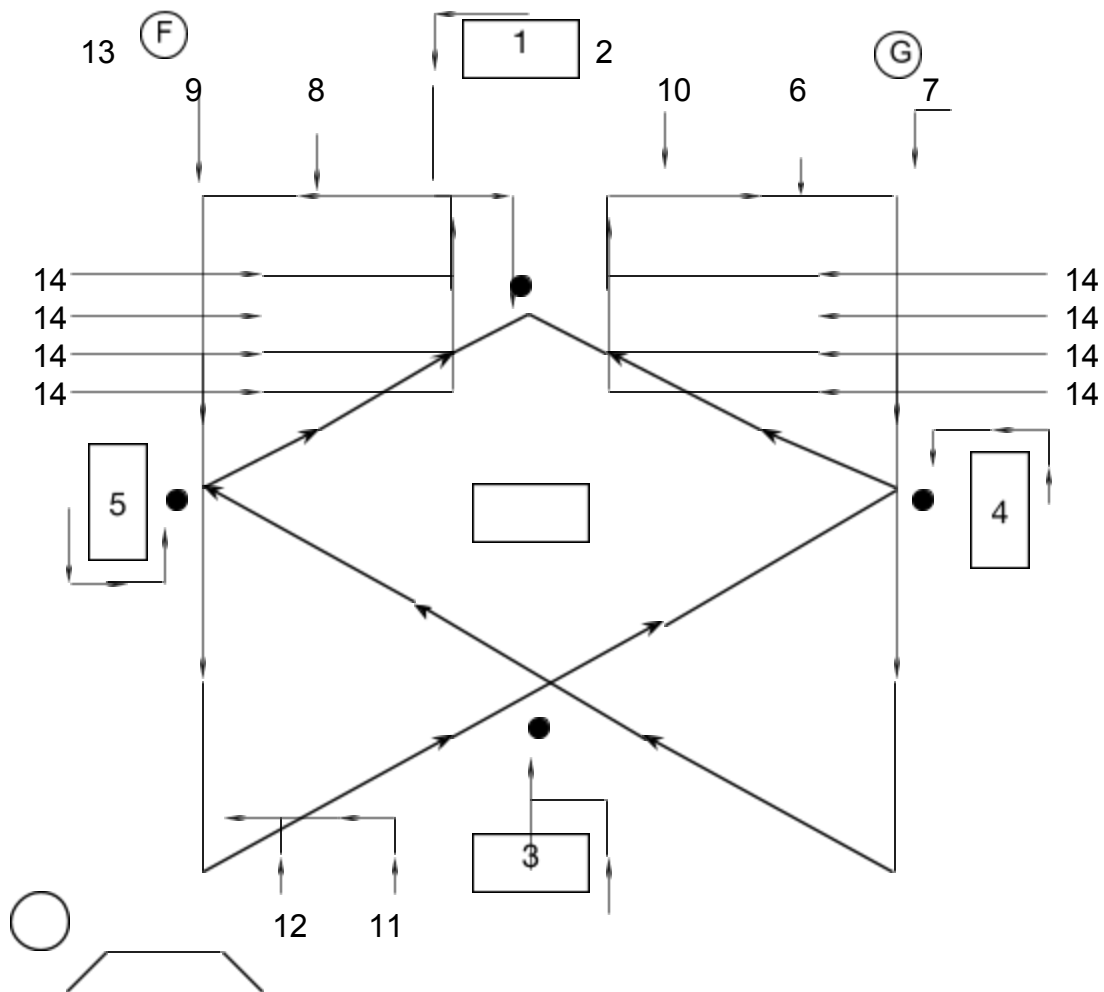

*The four Chair Officers will turn and go directly back to their places. All others will return to their places led by the Drill Team.*

DIAGRAM 6

RETURNING FROM THE DIAMOND

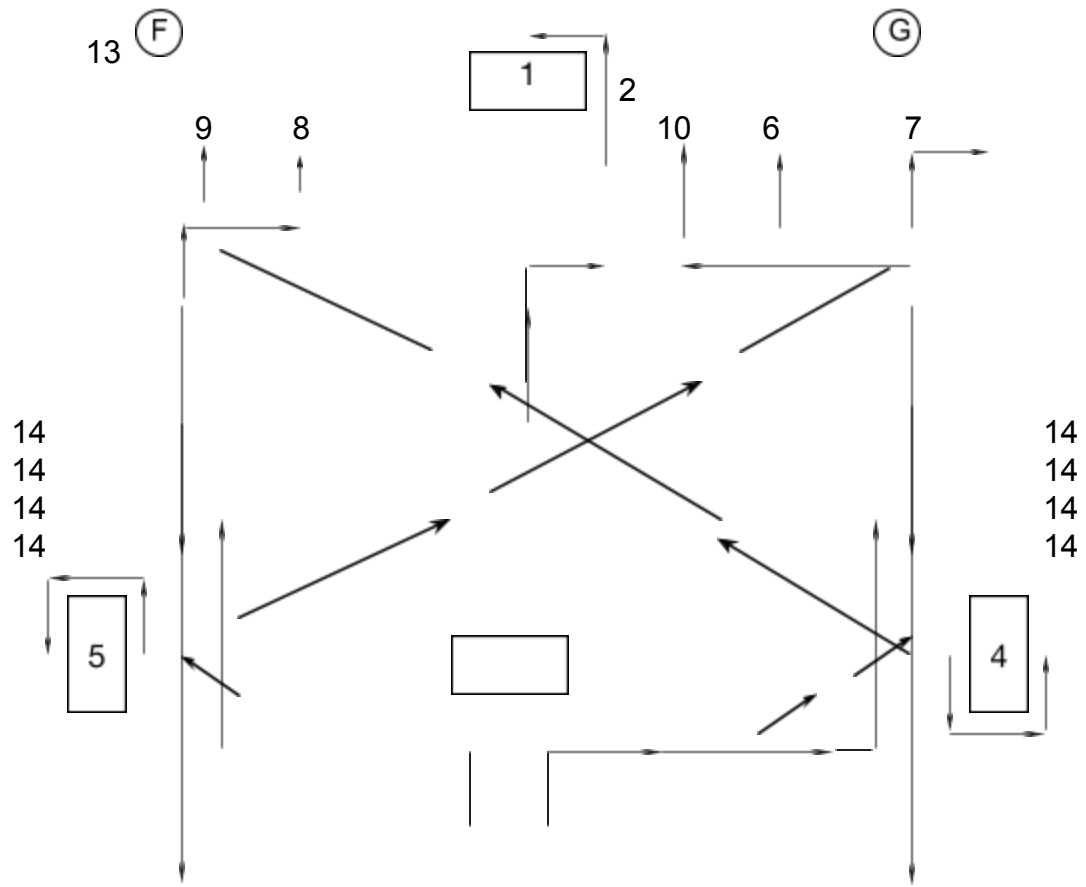

12 11

**CLOSING OF CENTRE STATION**

**PRESIDENT/HONOURED ROYAL LADY- \_\_\_\_\_ Chaplain, you will attend the Centre Station.**

*The Chaplain approaches the Centre Station and then repeats a closing prayer and closes the Bible.*

**CHAPLAIN - Oh Lord, protect, guard and guide all our Members and their families and bring Peace and Happiness to the world. Amen.**

**OR**

**Now that our meeting is over,  
And at the closing of the day  
Let Kindness and Love be our watchword  
As we pass along Life's way.  
May God grant us the wisdom  
And this of Thee we ask  
That we may soon meet again  
To work and resume our task. Amen.**

**OR**

**Lord, Bless us and our day's work.  
Keep us safe throughout the night.  
Fill us with understanding of Thy ways  
And the wisdom to judge our errors.  
Grant us the blessing of a new day and  
A new opportunity to serve Thee  
Amen.**

*They return to their respective positions.*

**DIAGRAM 7**

**CHAPLAIN ATTENDING CENTRE STATION**

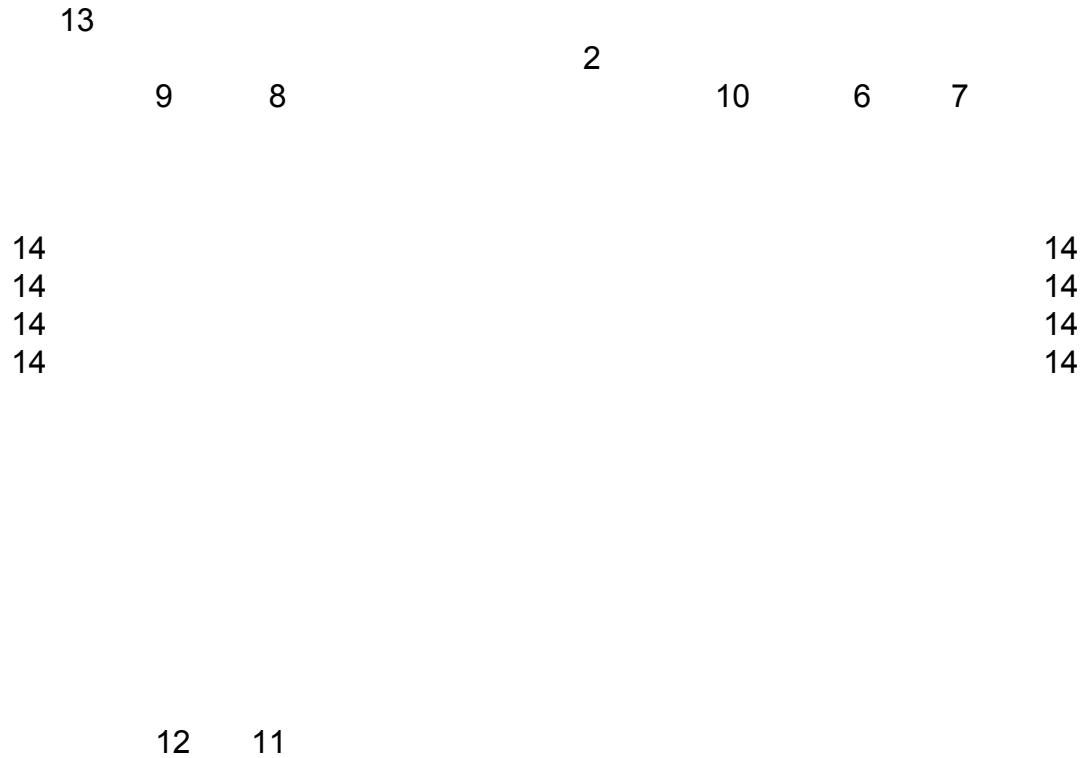

**PRESIDENT/HONOURED ROYAL LADY - I now declare \_\_\_\_\_ Lodge No. \_\_\_\_ of the Canadian Royal Purple closed until its next regular session, unless sooner convened in special meeting by my order.**

**PRESIDENT/HONOURED ROYAL LADY - (O)**

**Attachment #1**

**CHARTER DRAPING CEREMONY**

*Charter is placed on a stand in front of the President/Honoured Royal Lady position. The Drape is placed at the position of the Conductress, a spray of flowers at the Chaplain's position, and a single long-stemmed flower with each Member of the Drill Team.*

*The Charter is to remain draped for the meeting. Candles may be used if Lodge desires. It shall be optional to remain seated during this Ceremony. No gavel is used if remaining seated.*

*The Drill Team leaders may move the Centre Station to a spot at the back of the room for this ceremony; they will return the Centre Station to its position at the end of this service.*

**PRESIDENT/HONOURED ROYAL LADY - We are draping the Charter in memory of our beloved Member(s) \_\_\_\_\_, who passed away on \_\_\_\_\_ (date).**

*The Eulogy may be given at this time if Lodge desires. It may be given by a family member or friend if present or desired.*

**PRESIDENT/HONOURED ROYAL LADY - Secretary, you will call the name of our departed Member(s).**

*The Secretary calls the name three times. In the event of the death of more than one Member, the Secretary calls each name once.*

Pause - (-O-O-O-)

*If there are twelve (12) members on the Drill Team they shall take their places in the Cross formation as follows.*

- 1
- 2
- 3
- 5 7 8 6 4
- 9
- 10
- 11
- 12

**DIAGRAM 11**

**TEAM FORMING CROSS BELOW THE CENTRE STATION. CHAPLAIN  
AND CONDUCTRESS DRAPING THE CHARTER.**

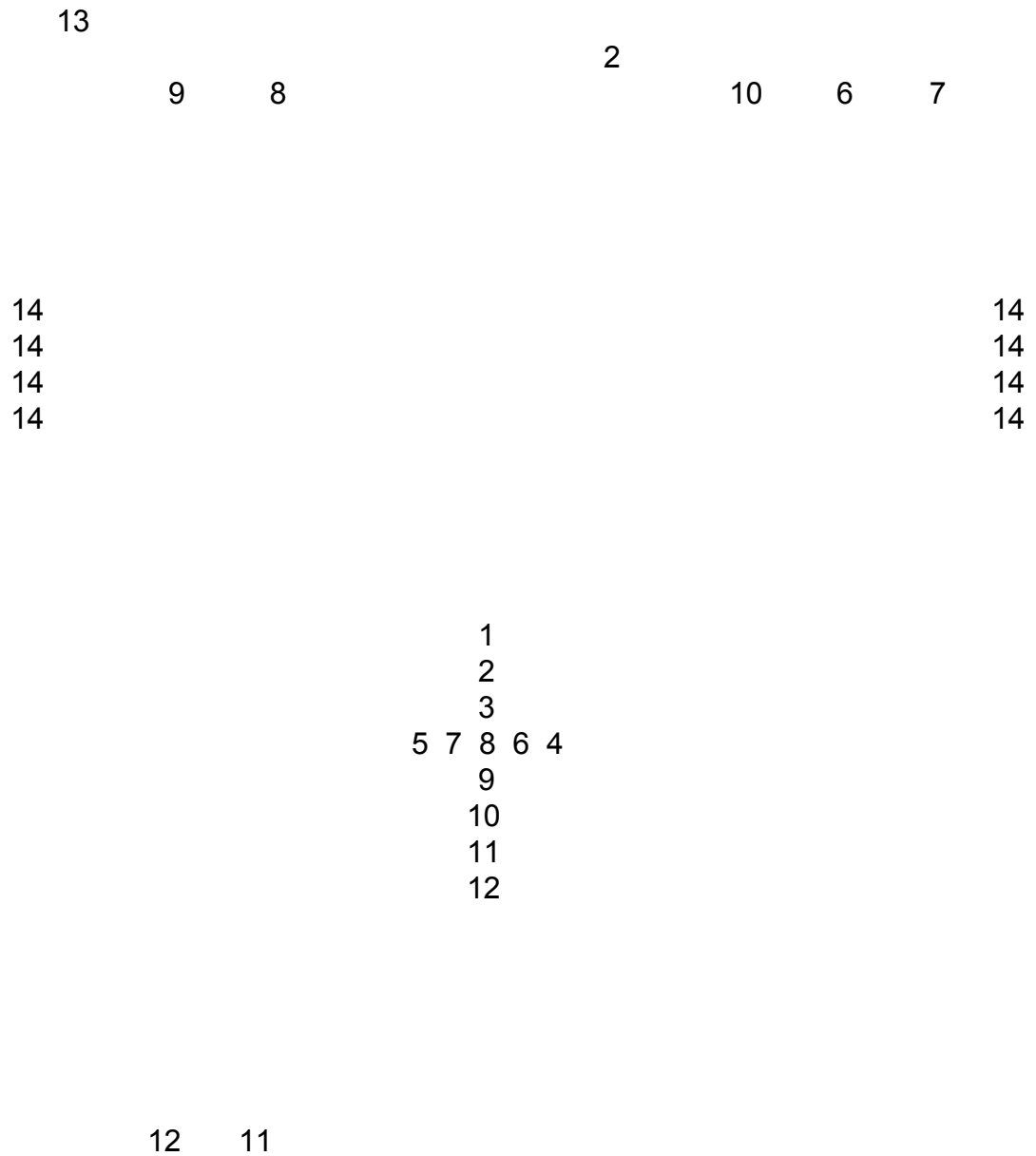

*If there are eight (8) Members on the Drill Team, they shall take their places in the Cross formation as follows:*

1  
2  
3 5 4  
6  
7  
8

**PRESIDENT/HONOURED ROYAL LADY** - It is our custom to pause, that we may in solemn hush pay sweet tribute to the sacred memory of our Member(s) who has/have answered the call of the Supreme Ruler of the Universe, and we, as Members of this Lodge, mourn their passing. In the garden of our memories will always remain a bright recollection of their stay with us.

*(Appropriate soft music if available.)*

*The Members stand to form the Cross and cradle the flowers in left arm as the Charter is being draped. The Drill Team shall remain standing until after the verse is said by the President/Honoured Royal Lady.*

*Chaplain carrying flowers and Conductress carrying the Drape march slowly down the room and back to the Charter stand; each Member of the Drill Team carrying a single long-stemmed flower, cradled in left arm, marches slowly behind the Conductress and Chaplain to their position below the Centre Station in Cross formation. There shall be no hesitation step.*



**DIAGRAM 12  
TEAM FORMING CROSS BELOW THE CENTRE STATION. CHAPLAIN  
AND CONDUCTRESS DRAPING THE CHARTER.**

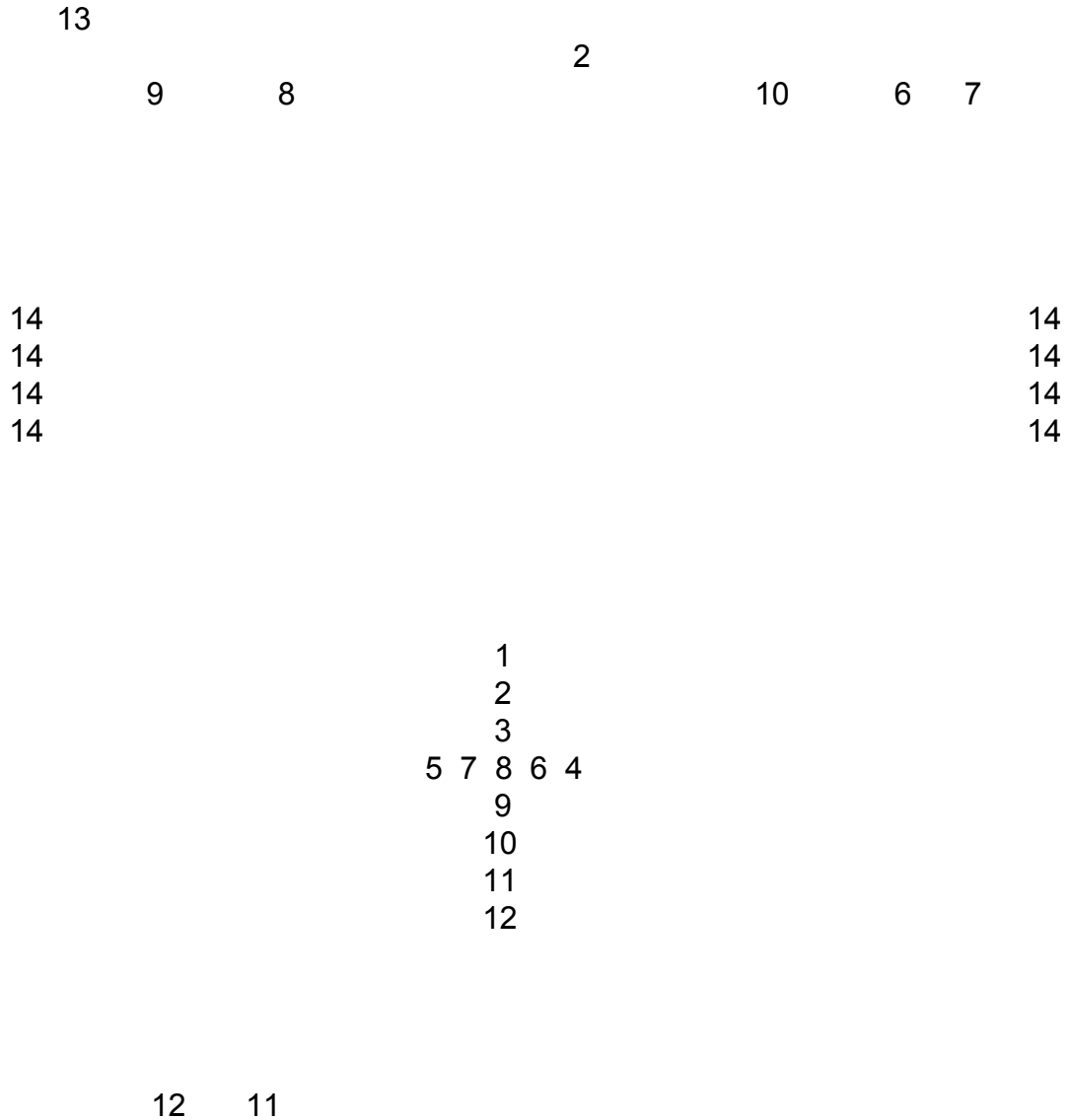

*The Conductress drapes the Charter and then the Chaplain places the flowers. When the Conductress and Chaplain have draped the Charter, they will turn and face the Centre Station.*

*When the Conductress and Chaplain are in position, the President/Honoured Royal Lady shall say the verse.*

**PRESIDENT/HONOURED ROYAL LADY –**

**They never quite leave us,  
our Members who have passed.  
A thousand sweet memories  
are holding them fast.**

**DIAGRAM 13**

**POSITION OF CHAPLAIN AND CONDUCTRESS AFTER DRAPING CHARTER.**

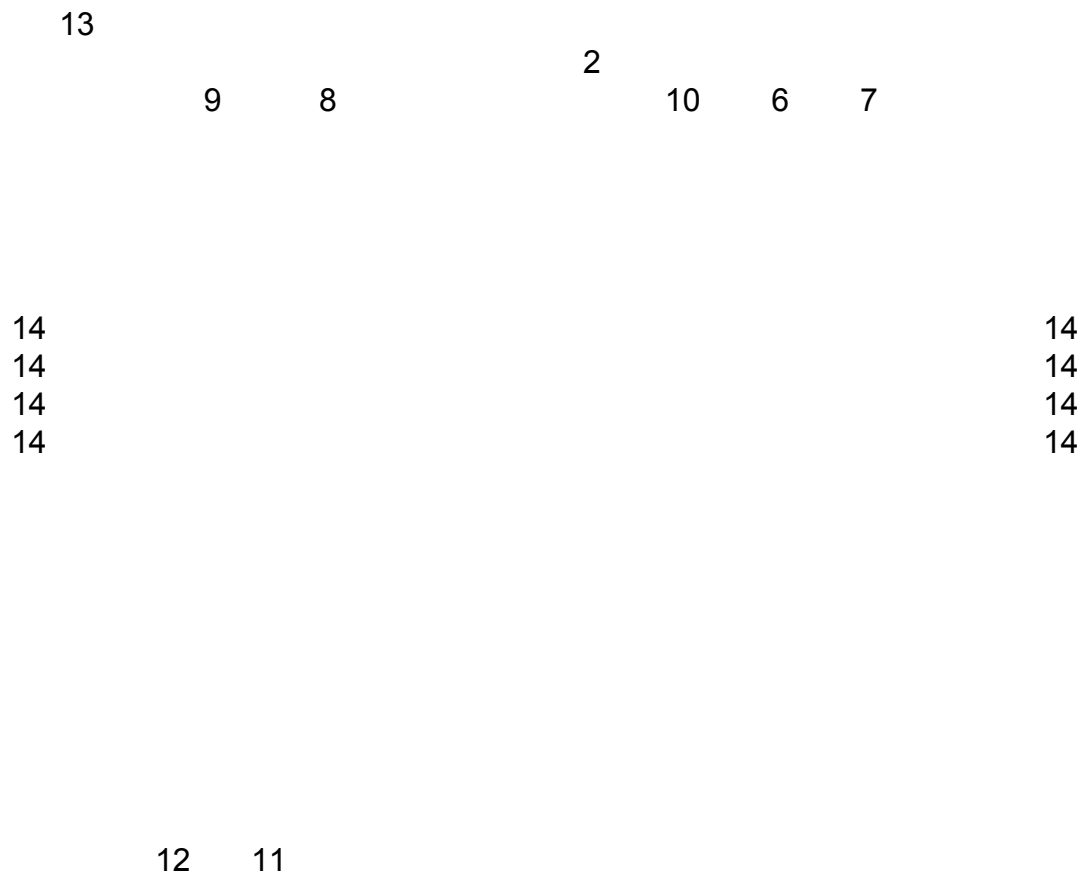

*A song or hymn is sung by the Lodge, or as a solo. The Drill Team does not sing. All Members resume their seats following the Hymn or solo.*

*No gavel is used.*

*When the Hymn is completed, the Conductress and Chaplain will proceed in a direct line to the Centre Station and PAUSE. Conductress and Chaplain shall position themselves so that the direct line of march shall be to the edge of the Centre Station*

*At the same time, numbers 1, 2, and 3 of the Drill Team will proceed out of the top of the Cross; the other numbers proceed beneath the arms of the Cross to follow numbers 1, 2 and 3. When the Drill Team has made their square below the arms of the Cross, numbers 1 and 2 will turn in line with the Conductress and Chaplain.*

*The Drill Team shall walk slowly in pairs to the Conductress and Chaplain, to whom they will hand their flowers in unison.*

*The Drill Team Members shall return directly to their places immediately after handing their flower to the Conductress and Chaplain and will remain standing; they resume their seats in unison with the Conductress and Chaplain.*

*Once the Conductress and Chaplain have received the flowers from the last member of the Drill Team, they shall turn in unison and proceed to the Charter stand and place the flowers, one at a time, in a suitable container (vase or basket) which has been provided for this purpose, at the base of the Charter stand.*

*When the flowers have been placed in the container, the Conductress and Chaplain shall return to their places and resume their seats.*

### DIAGRAM 14

#### CHAPLAIN AND CONDUCTRESS RECEIVING DRAPING FLOWERS AND DRILL TEAM RETURNING TO PLACES.

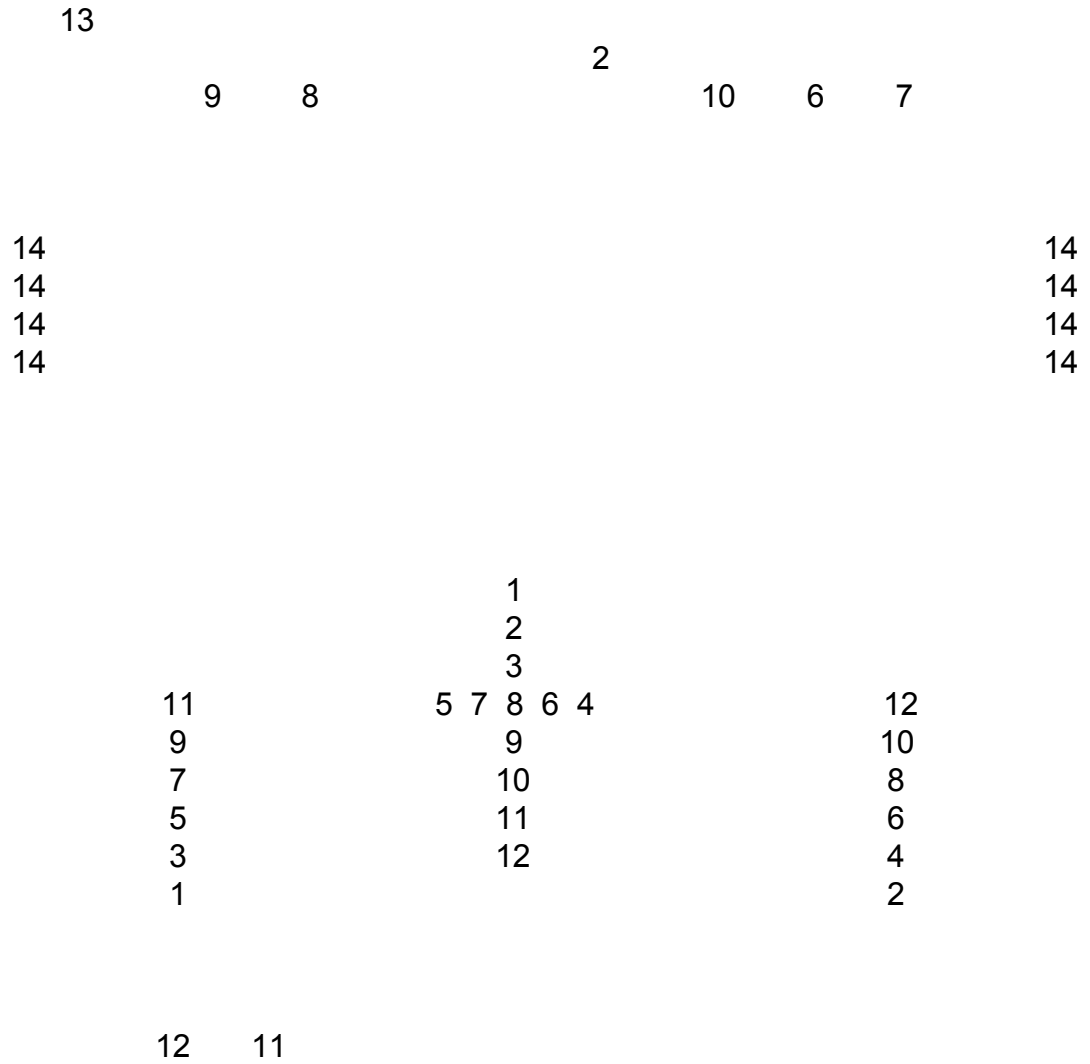

**DIAGRAM 15**  
**CHAPLAIN AND CONDUCTRESS PLACING DRAPING**  
**FLOWERS AND RETURNING TO PLACES.**

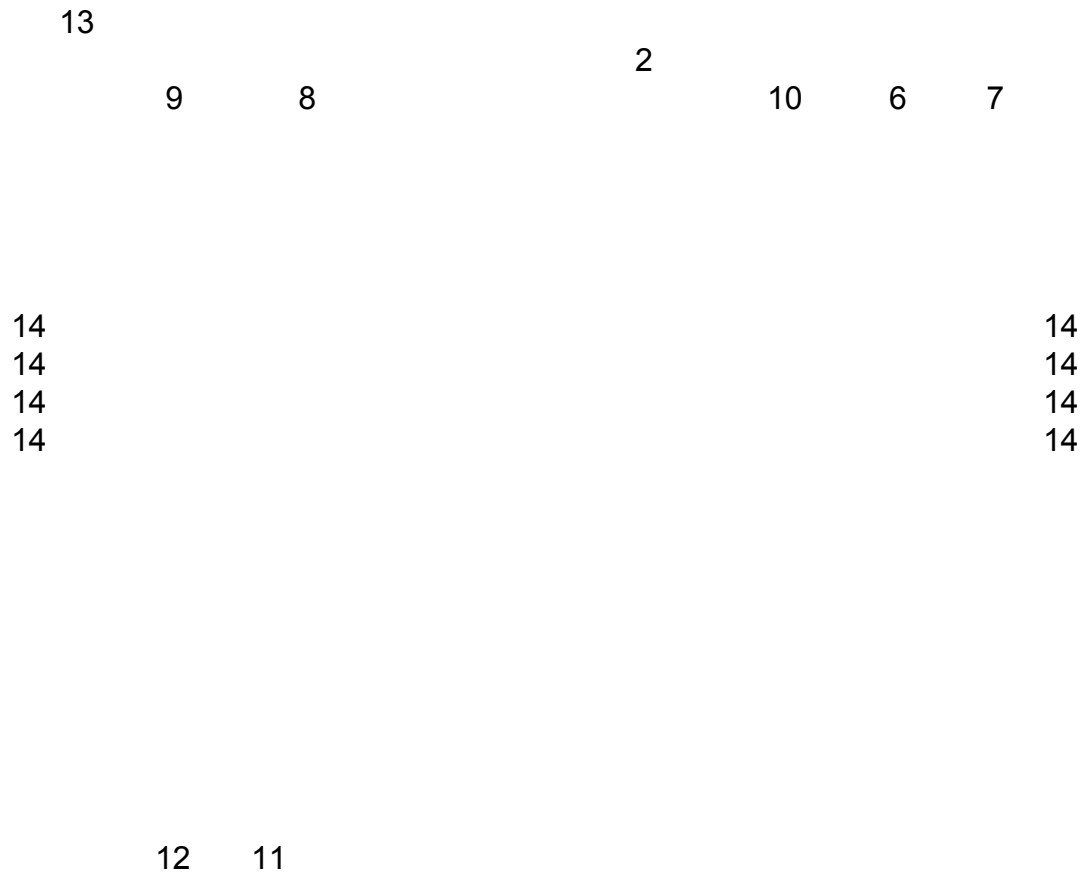

**CHARTER DRAPING CEREMONY WITHOUT DRILL TEAM**

**PRESIDENT/HONOURED ROYAL LADY - We are draping the Charter in memory of our beloved Member(s), \_\_\_\_\_, who passed away on \_\_\_\_\_ (date).**

*The Eulogy may be given at this time if Lodge desires. It may be given by a family member or friend if present or desired.*

**PRESIDENT/HONOURED ROYAL LADY – Secretary, you will call the name of our departed Member(s).**

*The Secretary calls the name three times. In the event of the death of more than one Member, the Secretary calls each name once.*

Pause - (-O-O-O-)

**PRESIDENT/HONOURED ROYAL LADY - It is our custom to pause, that we may in solemn hush pay sweet tribute to the sacred memory of our Member(s) who has/ have answered the call of the National Ruler of the Universe, and we, as Members of this Lodge, mourn their passing. In the garden of our memories will always remain a bright recollection of their stay with us.**

*(Appropriate soft music if available.)*

*Chaplain carrying flowers and Conductress carrying Drape march slowly down the room turn and proceed to the President/Honoured Royal Lady's Position. There shall be no hesitation step.*

*Conductress and Chaplain appropriately Drape the Charter and place flowers. Conductress and Chaplain will turn and proceed down the room and return to their positions.*

*Once the Conductress and Chaplain are at their positions they will in unison resume their seats.*

*When the Conductress and Chaplain are seated the President/Honoured Royal Lady says the following verse:*

**PRESIDENT/HONOURED ROYAL LADY:**

**They never quite leave us,  
our Members who have passed.  
A thousand sweet memories  
are holding them fast.**

*A song or hymn is sung by the Lodge, or as a solo.*

**Attachment #2**

**PROGRAM FOR MEMORIAL DAY**

*Each Lodge may designate by Bylaw a day to pay tribute to the memory of departed Members for the past year. ALL LODGES SHALL OBSERVE THIS SPECIAL DAY in memory of departed Members.*

*(Candles may be used if Lodge desires.)*

**PRESIDENT/HONOURED ROYAL LADY - Our Memorial Service is held annually, that we may pay tribute to our departed Members. (-O-O-O-)**

**The Book of Life is closed  
For those we loved so well,  
But the kindly tales of years well spent  
Are what the pages tell.  
Each one contains a thought  
As lovely as can be  
For us to keep within our hearts  
Enshrined in memory.**

*The Chaplain will lead in repeating the Lord's Prayer. If the Memorial Service is held at a regular Lodge meeting, the Lord's Prayer may be omitted during the Memorial Service. If a Lodge has no deceased members, the President/Honoured Royal Lady will omit the following:*

**PRESIDENT/HONOURED ROYAL LADY - \_\_\_\_\_ Secretary, you will read the name(s) of our departed member(s) from the past year. (If the Lodge wishes, the names of all departed members can be read.)**

*The Secretary reads name(s) and date(s) of demise in rotation.*

**PRESIDENT/HONOURED ROYAL LADY - Members, we will observe one minute of silence in respect to all departed Members of the Canadian Royal Purple.**

*Pause one minute silence.*

**PRESIDENT/HONOURED ROYAL LADY -**

**With cherished memories of our departed Members,  
We recall with tenderness, the pleasant associations  
With those who were so dear to us.  
We remember their dedication  
To the ideals and principles of our Society.**

**1ST VICE PRESIDENT/ASSOCIATE ROYAL LADY -**

**Their Charity to others bettered our Community,  
Our Country, and the world at large.**

**2ND VICE PRESIDENT/LOYAL LADY -**

**They taught us integrity and honesty.  
We remember their dedication  
To the principle of Justice.**

**3RD VICE PRESIDENT/LECTURING LADY –**

**Love is aligned with honour and truth.  
This lesson they taught us well.  
A beautiful memory they left behind.  
The principle of Love to tell.**

***Hymn***

**CHAPLAIN –** *(May read a passage from the Bible if Lodge desires)*

**CHAPLAIN –** Almighty God, comfort those who mourn the passing of our beloved members. Give us the strength to continue the work as members of the Royal Purple.

**AMEN.**

**HONOURED ROYAL LADY – (-O-)**



**Attachment #3**

**FUNERAL SERVICE FOR A DEPARTED MEMBER  
OF CANADIAN ROYAL PURPLE**

*Guidelines for a service conducted by Members as requested by the family.*

*Have the family choose the solos or hymns and also the person they prefer to have present the Eulogy.*

*Officers gather around the casket with Members standing in a circle (or semicircle) behind the Officers. This procedure is also suitable to be used at a graveside.*

**PRESIDENT/HONOURED ROYAL LADY CHAPLAIN**

**3rd VICE-PRES/LECTURING  
LADY**

**2nd VICE-PRES LOYAL  
LADY**

**1st VICE-PRES/ASSOCIATE ROYAL LADY**

**PRESIDENT/HONOURED ROYAL LADY - We have gathered here today to pay special tribute to the memory of our departed Member \_\_\_\_\_ who passed away \_\_\_\_\_.**

**They never quite leave us our Members who have passed.  
A thousand sweet memories are holding them fast.**

*The Chaplain will lead in repeating the Lord's Prayer.*

*Solo (Optional)*

**PRESIDENT/HONOURED ROYAL LADY -**

Somewhere back of the sunset,  
Where loveliness never dies,  
Our Member lives in a land of glory,  
'Mid the blue and gold of the skies.

**1ST VICE PRESIDENT/ASSOCIATE ROYAL LADY-**

And we who have known and loved them,  
Whose passing has brought sad tears,  
Will cherish their memory always,  
To brighten the passing years.

**2ND VICE PRESIDENT/LOYAL LADY -**

Beyond the sunset they have gone,  
To dwell where there is no night,  
And there they live forever,  
Though out of mortal sight.

**3RD VICE PRESIDENT/LECTURING LADY-**

Picture with me a garden,  
A place serene and fair,  
A place where peace abides,  
And love finds its dwelling there.

**CHAPLAIN -**

There is a gate to this garden,  
Through which each must go alone,  
And there by a light which we cannot see,  
Our Master claims His own.  
Beyond the gates our loved ones  
Find happiness and rest,  
And we find comfort in the faith  
That a loving God knows best.

*All Members of the Lodge, with the exception of the President/Honoured Royal Lady and Chaplain return to their seats.*

*The Eulogy is given followed by a Solo (Optional)*

*The Chaplain will read the 23rd Psalm;*

**The Lord is my shepherd, I shall not want.  
He maketh me to lie down in green pastures.  
He leadeth me beside the still waters.  
He restoreth my soul.**

**He leadeth me in the paths of righteousness for His name's sake.  
Yea though I walk through the valley of the shadow of death,  
I will fear no evil; for Thou art with me; Thy rod and Thy staff they comfort me.**

**Thou preparest a table before me in the presence of my enemies;  
Thou anointest my head with oil; my cup runneth over.**

**Surely such goodness and mercy shall follow me all the days of my life  
And I will dwell in the house of the Lord forever.**

**PRESIDENT/HONOURED ROYAL LADY- To \_\_\_\_\_ family we extend our sincere sympathy and we hope the following verse will give comfort in the loss of your loved one.**

**THO I AM GONE**

**Weep not, nor mourn my passing.  
I'm in my heavenly home.  
My body tired, my spirit weak,  
My Saviour called me home.**

**The years we shared were precious  
But this time was meant to be.  
Tho I am gone from earthly view  
I'll be there in memory.**

**Love and care for each other  
Tho on earth I dwell no more.  
We'll meet again someday  
On that eternal shore.  
Amen**

**CHAPLAIN - Almighty God, Father of mercies and giver of all comfort; deal graciously, we pray Thee, with all those who mourn, that casting every care on Thee, they may know the consolation of Thy Love. AMEN.**

*The President/Honoured Royal Lady will make any final announcements (place and time of reception, etc.if applicable).*

## **ROYAL PURPLE MEMORIAL/FUNERAL SERVICE WITH NO CASKET**

*A table is placed in the front with a picture of the deceased and/or memorabilia of their life.*

*Each Officer attending the service may carry a white flower to be placed in a vase on the table or to lay on the table near the picture.*

*After the regular service is completed, the Lodge members will conduct the Funeral Service as per ritual with the Lodge President (Honoured Royal Lady) standing at a point and Officers forming a 'V'. Verses for service will be as per ritual.*

Table with the  
Memorabilia

President/Honoured Royal Lady \*

3rd V.P./ Lecturing Lady \*

\* Chaplain

1st V.P./Associate Royal Lady \*

\* 2nd V.P./Loyal Lady

*Members who take part in the Service will leave the Church or Funeral Home and provide an Honour Guard for immediate family members who are entering the limousines or private cars in the front of the Funeral Home or Church*

## **FUNERAL CEREMONY**

*Each Officer and member attending the funeral may carry a white flower to be placed on the casket as they file past.*

*If desired, a Eulogy may be given.*

**PRESIDENT/HONOURED ROYAL LADY - Our Lodge is saddened by the passing of our beloved Member \_\_\_\_\_.**

*(Pause)*

**PRESIDENT/HONOURED ROYAL LADY-**

Somewhere back of the sunset,  
Where loveliness never dies,  
Our Member lives in a land of glory,  
'Mid the blue and gold of the skies.

**1ST VICE PRESIDENT/ASSOCIATE ROYAL LADY -**

And we who have known and loved them,  
Whose passing has brought sad tears,  
Will cherish their memory always,  
To brighten the passing years.

**2ND VICE PRESIDENT/LOYAL LADY -**

Beyond the sunset they have gone,  
To dwell where there is no night,  
And there they live forever,  
Though out of mortal sight.

**3RD VICE PRESIDENT/LECTURING LADY -**

Picture with me a garden,  
A place serene and fair,  
A place where peace abides,  
And love finds its dwelling there.

**CHAPLAIN -**

There is a gate to this garden,  
Through which each must go alone,  
And there by a light which we cannot see,  
Our Master claims His own.  
Beyond the gates our loved ones  
Find happiness and rest,  
And we find comfort in the faith  
That a loving God knows best.

**HYMN**

*The Lord's Prayer, or suitable Benediction of the following may be used at the discretion of the President/Honoured Royal Lady.*

**CHAPLAIN -** Almighty God, Father of mercies and giver of all comfort; deal graciously, we pray Thee, with all those who mourn, that casting every care on Thee, they may know the consolation of Thy Love. **AMEN.**

**PRES. /H.R.L. CHAPLAIN**

**3<sup>rd</sup> VP/  
LECTURING LADY**

**2<sup>nd</sup> VP/LOYAL LADY**

**1ST V.P./ASSOCIATE ROYAL LADY**

*Above Officers will assume this position at the service. Members shall remain at their seats. If the service is at the graveside, the Officers and Members shall take their places in a row or rows near the casket.*

**Attachment #4**

**INITIATION**

*The use of a Drill Team during the Initiation Ceremony will be optional. Candles are optional.*

**PRESIDENT/HONOURED ROYAL LADY:** Secretary, are all applications for Membership complete and in order to proceed with this Initiation?

**SECRETARY:** President/Honoured Royal Lady, they are.

**PRESIDENT/HONOURED ROYAL LADY:** Chaplain you will light the candle on the Centre Station.

**DIAGRAM 19 – CHAPLAIN LIGHTING CANDLE**

*The President/Honoured Royal Lady, 1st Vice President/Associate Royal Lady, 2nd Vice President/Loyal Lady and 3rd Vice President/Lecturing Lady will rise and light their candles in unison with the Chaplain..*

**PRESIDENT/HONOURED ROYAL LADY:** \_\_\_\_\_ Conductress, you will present the Prospective Member(s) to the Centre Station. (escorted by the Drill Team optional)

**DIAGRAM 8  
DRILL TEAM AND CONDUCTRESS  
PICK UP PROSPECTIVE MEMBER(S)**

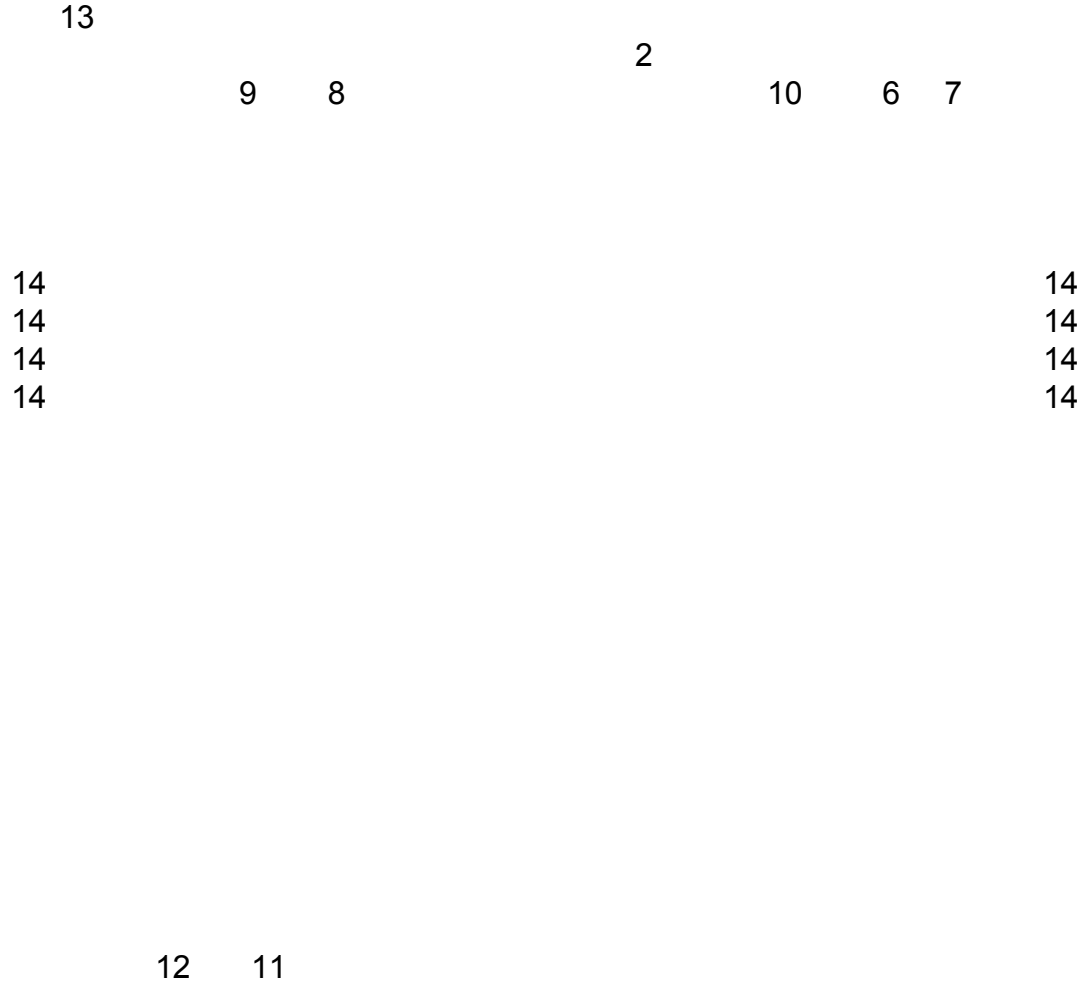

*While the Conductress is presenting the Prospective Member(s) at the Centre Station, the President/Honoured Royal Lady and Chaplain will take their positions at the Centre Station and the Immediate Past President/Immediate Past Honoured Royal Lady will assume the station of the President/Honoured Royal Lady. The Drill Team will remain with the Prospective Member(s).*

*The following procedure shall be used:*

- a) One Prospective Member - Conductress offers their left arm to the Prospective Member
- b) Two Prospective Members - Conductress walks between them offering an arm to each.
- c) Three Prospective Members - The Conductress offers their left arm to a Prospective Member and the others follow by two's.
- d) The Conductress and Prospective Member(s) go around the Centre Station as follows:  
*If one Prospective Member, the Conductress and Prospective Member separate.*  
*If two Prospective Members, the Conductress goes with the Prospective Member to the right, the other Prospective Members go to the left*
- e) When the Conductress walks alone behind the Drill Team, they take the outside line of march.

*Drill Team, Conductress and Prospective Member(s) approach the Centre Station from the station of the 1st Vice President/Associate Royal Lady. The Drill Team leads the Conductress and Prospective Member around the room clockwise.*

*If the Prospective Member(s) sits on the side of the 3rd Vice President/Lecturing Lady's side of the room, the Drill Team will lead the Conductress and Prospective Member(s) around the room clockwise until the position of the 1st Vice President/Associate Royal Lady is reached and then approach the Centre Station.*

**CONDUCTRESS: President/Honoured Royal Lady, I wish to present \_\_\_\_\_ to this assembly.**

*President/Honoured Royal Lady asks the following question:*

**PRESIDENT/HONOURED ROYAL LADY: You have been instructed in the laws and principles of our great Order. Are you prepared to obligate yourself to those laws and principles?**

**PROSPECTIVE MEMBER(S): I am.**

**PRESIDENT/HONOURED ROYAL LADY: \_\_\_\_\_ Conductress, you will now place the Prospective Member(s) in the proper position to receive the Obligation.**

**IMMEDIATE PAST HONOURED ROYAL LADY: Members, you will rise and repeat the Obligation using the Obligation sign in conjunction with the Prospective Member(s).  
(-O-O-O-)**

**LODGE PRESIDENT/HONOURED ROYAL LADY: Place your right hand over your heart and repeat after me the following Obligation, using your name where I use mine.**

*Together the Members and the Prospective Member(s) will repeat the Obligation.*



## OBLIGATION

I, \_\_\_\_\_, promise to be true to the laws of Canada, and to the laws of the Canadian Royal Purple. I will uphold and endeavor to promote the Principles of JUSTICE, CHARITY, LOVE, and SERVICE. All this I promise to fulfill to the best of my ability.

**CHAPLAIN:** Almighty God, the reader of our minds and hearts, you have heard the promises made by our Members; give them strength and courage to go forward in the great work for which we stand. AMEN.

**PRESIDENT/HONOURED ROYAL LADY:** Remember well these words you have spoken. Let them dwell in your hearts, never to be forgotten.

## INITIATION ODE

With robes of Royal Purple, our Noble Order clothed,  
Its precepts and its teachings, by all of us beloved,  
Protected by its raiments of virtue, duty, love,  
Our firm faith in our Members is true as stars above.  
And when 'tis time to say good-bye, to friends and loved ones dear  
We want to have our Members of the Royal Purple near.  
So, Lord, teach us ne'er to forget, the vow sincere we took,  
That we may surely have our names inscribed within your book.

*The Chaplain returns to their seat during the singing of the Initiation Ode.*

*The President/Honoured Royal Lady remains at the Centre Station.*

*1st Vice President/Associate Royal Lady, 2nd Vice President/Loyal Lady and 3rd Vice President/Lecturing Lady will assume their positions in front of the Centre Station beside the President/Honoured Royal Lady as follows: 1st Vice President/Associate Royal Lady, leaves their position on the right, the 2nd Vice President/Loyal Lady will wait until the 1st Vice President/Associate Royal Lady passes their position, then falls in behind.*

**IMMEDIATE PAST PRESIDENT (IMMEDIATE PAST HONOURED ROYAL LADY): (-O-)**

**LODGE PRESIDENT /HONOURED ROYAL LADY:** Our Chair Officers will now instruct you in the four Principles of our Order: **JUSTICE, CHARITY, LOVE, and SERVICE.** The 1st Vice President/Associate Royal Lady will give instruction on the Principle of Charity.

**1ST VICE PRESIDENT/ASSOCIATE ROYAL LADY** - The principle of Charity is a two-fold blessing, it blesses those who give and those who receive. Giving to the needy and less fortunate betters our community, our Country and the world at large. Our Charity is spontaneous. Whenever misery can be relieved or the tears of sorrow dried, there will be found work for a Member of the Royal Purple.

**2ND VICE PRESIDENT/LOYAL LADY** - The principle of Justice is a principle of integrity and honesty through which we stimulate the spirit of mankind toward noble citizenship. Justice is that standard which teaches us to deal fairly with others. As a Member of this Society, you are entitled to all rights and privileges. It is your duty to assume this responsibility to ensure the democratic process. The Member Services Committee has instructed you in the signs and tokens of our Society on which our meetings are conducted.

**3RD VICE PRESIDENT/LECTURING LADY** - Love is an important principle in the work of our Society. It should influence us to remember the commendable qualities of a Member overlooking imperfections. Love is associated with honour and truth. It is sincere. It is compassionate. Love given without looking for return will bring happiness into the lives of others.

**PRESIDENT/HONOURED ROYAL LADY** - Service is the Principle of dedication. We must always strive to be true to our Obligation, to live within the laws of Canada and to act towards one another with Justice, Charity, Love and Service. Remember that in fulfilling our Obligation, life will be more rewarding and the world will be a better place in which to live.

## OFFICERS TAKING PLACES AT CENTRE STATION

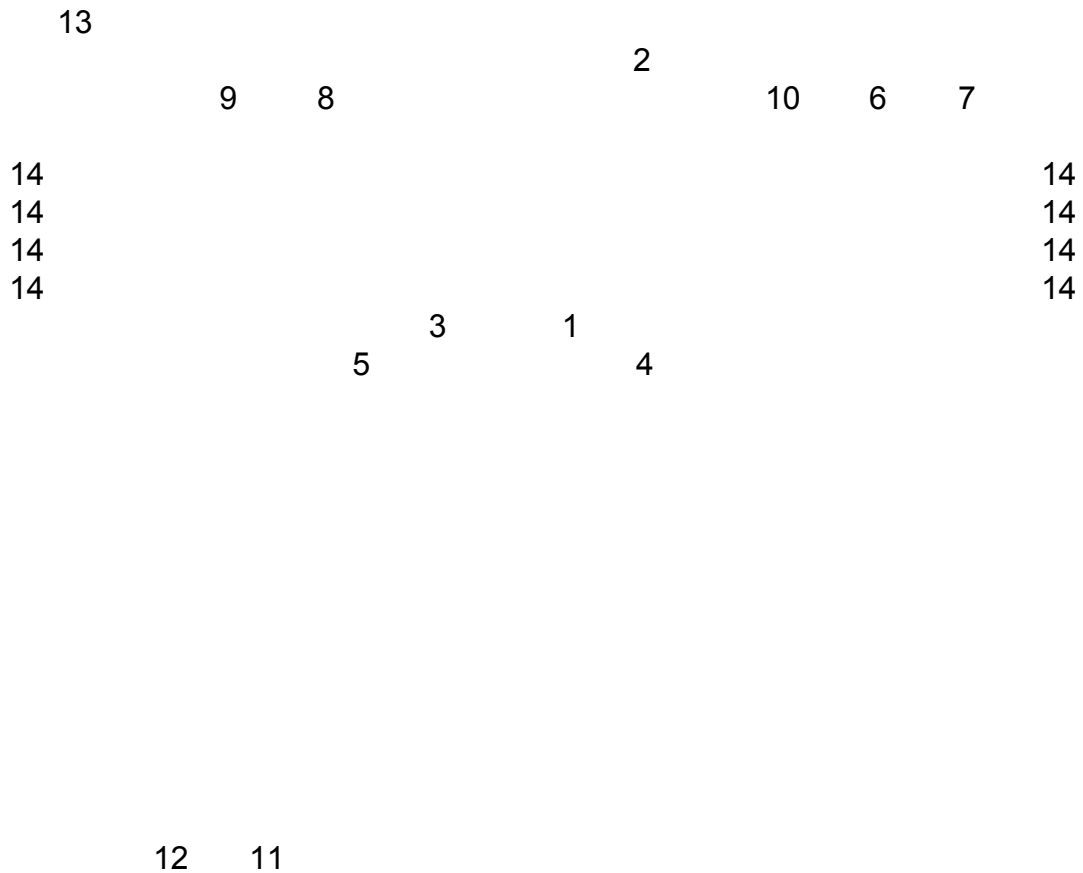

*Upon completion of the Charges, the President/Honoured Royal Lady, 1st Vice President/Associate Royal Lady, 2nd Vice President/Loyal Lady and 3rd Vice President /Lecturing Lady will return to their places.*

**PRESIDENT/HONOURED ROYAL LADY:** You have now learned from the respective Officers, the great Principles of our Society, which are made stronger through the influence of frequent association. They increase as we become more interested in each other's welfare. Conductress, you will conduct our new Member(s) to their seats. (Escorted by the Drill Team)

*After the new Members have been seated the Conductress will return to their place. Welcoming March optional (see Section 4 Formal Meeting Procedures)*

## **PANSY CEREMONY (Optional)**

*(Lights to be dimmed)*

*When the President/Honoured Royal Lady calls "Justice" the, 2nd Vice President /Loyal Lady will immediately stand, as will the other two Officers as their Principles are called.*

**PRESIDENT/HONOURED ROYAL LADY - I ask you to listen attentively while JUSTICE, CHARITY, LOVE and SERVICE approach our Centre Station, that they may give to each one of us a thorough understanding of the importance of these great principles.**

*When these four Chair Officers are standing, they shall, in unison, pick up their Pansies and stand in front of their respective positions. The Pansy is held in the right hand, with the flower resting on the palm of the left hand. While the President/Honoured Royal Lady is away from their station, the station is occupied by the Immediate Past President/Immediate Past Honoured Royal Lady. When all Chair Officers are in front of their respective positions, they shall, in unison, approach the Centre Station, stopping at a point two paces away from the Centre Station. The Pianist (if available) shall supply appropriate music as Officers approach the Centre Station.*

**2ND VICE PRESIDENT/LOYAL LADY- I hold in my hand the floral emblem of our Society, a purple Pansy, and pray that at all times JUSTICE will prevail and shine forth in all our actions.**

**1ST VICE PRESIDENT/ASSOCIATE ROYAL LADY - As the gentle rain beautifies this Pansy, let us remember that the greatest of all virtues is CHARITY and that it should be practiced in all our undertakings.**

**3RD VICE PRESIDENT/LECTURING LADY - All nature changes, even this Pansy, but our LOVE is made stronger in the knowledge that by our actions cheer and happiness are brought into the lives of others.**

**PRESIDENT/HONOURED ROYAL LADY - As I hold this Pansy, I pray that our lives will be lives of SERVICE, that we will be faithful to our Obligation and act towards each other with JUSTICE, CHARITY, LOVE and SERVICE. May God bless this Lodge.**

*When the President/Honoured Royal Lady finishes their verse, all four Chair Officers take two steps in and place the Pansies on the Centre Station.*

*Immediately after this, "Bless This Lodge" or "Blest Be the Tie" is sung either as a solo or quietly in unison.*

*During the singing, the four Chair Officers take up the Pansy Chain, step back making a complete diamond with the Chain, step forward and place the Pansy Chain on the Centre Station, then turn in unison and slowly return to their places and remain standing.*

## BLESS THIS LODGE

TUNE: "BLESS THIS HOUSE"

Bless this Lodge, Oh Lord we pray,  
Make it grow from day to day.  
Bless our Members one and all  
Help us follow duty's call.

*(Pick up chain)*

May we walk in friendship's way,  
Do kind deeds without delay  
Lives of service full and free  
A place of service Lord to Thee..  
(Open chain)

From our actions may we find  
Justice done to all mankind  
That this Lodge may ever be  
Full of Love and Service free  
Help us ever one and **all**.

*(return chain)*

Harken to the needy's call.  
Then our Lodge will grow to be  
A place of Service Lord to Thee.  
Bless this Lodge and grant that we  
May live, Oh Lord for Thee  
(return chain)

*ALL turn in unison and return to their position*

## BLEST BE THE TIE

Blest be the tie that binds  
Our hearts in Christian **love**.  
(Pick up chain)

The fellowship of kindred minds  
Is like to that **above**.  
(Step back)

God who this diamond keeps,  
He slumbers not nor **sleeps**.  
(return chain)

In perfect peace keep Thee and me  
Through all **eternity**.  
(turn in unison and return to position)

**DIAGRAM 10  
PANSY CEREMONY**

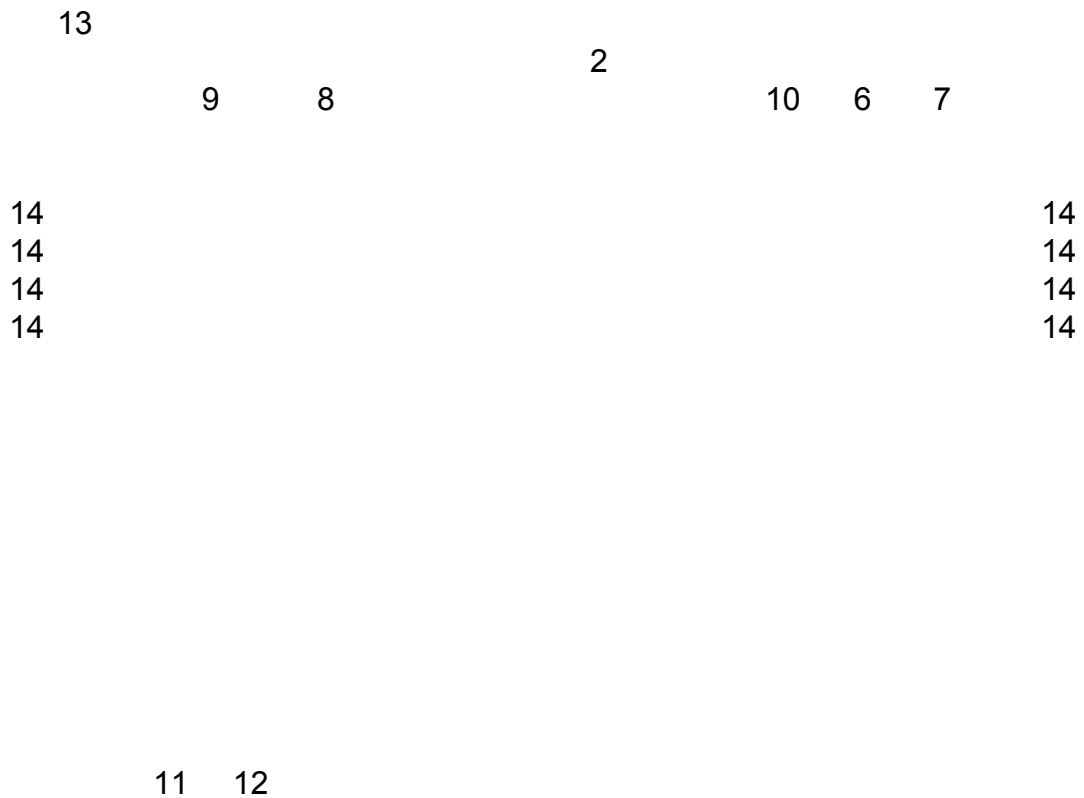

*Top view of Centre Station to illustrate position of Pansies on the Centre Station. Line of march taken by four Chair Officers.*

*The Chaplain extinguishes the candle on the Centre Station without form. The respective Chair Officers will also extinguish their candles in unison. Chaplain returns to her station.*

*No rap of the gavel is given.*

***Following the Pansy Ceremony, a Drill of the Lodge's choice may be exemplified.***

**Attachment #6**

**NOMINATIONS AND ELECTION OF OFFICERS**

*On the night of Election of Officers, the President/Honoured Royal Lady shall instruct the Conductress and Chaplain to inspect all dues receipt cards prior to the time the President/Honoured Royal Lady calls the Lodge to Order.*

*Under Order of Business Special Committee Reports, the President/Honoured Royal Lady shall call upon the Chairman of the Nominating Committee to give their report*

**COMMITTEE CHAIRMAN** - In accordance with the provisions of the Regulations, your Nominating Committee desires to place in nomination the following:

*The complete list of nominees, having been written on a blackboard or poster board prior to the meeting, is revealed and read by the Chairman at this time.*

**PRESIDENT/HONOURED ROYAL LADY** - we will now have the Nominations and Election of Officers. You have heard the report of the Nominating Committee. Our Regulations also provide for Nominations from the floor. Are there further nominations for any office reported by the Nominating Committee?

*Pause, rap the gavel, and repeat the question two more times in the same manner.*

*If there are no other nominations, the President/Honoured Royal Lady says:*

**PRESIDENT/HONOURED ROYAL LADY** - Nominations are now closed. Secretary, you will cast the vote of the Lodge in favor of the slate of Officers as presented by the Nomination Committee.

*If there are nominations from the floor, the President/Honoured Royal Lady says:*

**PRESIDENT/HONOURED ROYAL LADY** - Nominations are now in order for the Office of \_\_\_\_\_. Are there any other nominations?

*Pause, rap the gavel and repeat the question two more times in the same manner. If there are no other nominations, the President/Honoured Royal Lady says:*

**PRESIDENT/HONOURED ROYAL LADY** - Nominations are now closed. Secretary, you will cast the vote of the Lodge in favour of \_\_\_\_\_ and I declare you elected to the Office of \_\_\_\_\_ by acclamation.

*If there are no other nominations, the President/Honoured Royal Lady says*

**PRESIDENT/HONOURED ROYAL LADY - \_\_\_\_\_ I declare you elected to the Office of \_\_\_\_\_.**

*The above procedure is to be used for nominations from the floor. For the Office of Secretary, the President/Honoured Royal Lady shall request a Member other than the Secretary to cast the vote of the Lodge*

*The Secretary shall place the name of each candidate elected by acclamation or by ballot in a separate envelope, seal the envelope and keep for thirty (30) days after which time all ballots will be destroyed.*

**Attachment #7**

**SHORT FORM OPENING AND CLOSING FOR  
INSTALLATION OF OFFICERS**

**If Installation of Officers takes place on a night other than a regular meeting night, short form Opening and Closing may be used as follows:**

- 1. CHAPLAIN Attends the Centre Station**
- 2. Declare the Lodge Open**
- 3. Introduction of Dignitaries and Guests**
- 4. Hand gavel to Installing Officer**
- 5. Acknowledgement of Report on Membership fees**
- 6. Installation ceremony as follows or from the Formal Meeting Procedures**
- 7. Installation Prayer**
- 8. Installing Officer returns gavel**
- 9. *President/Honoured Royal Lady* expresses appreciation to the Installing officers**
- 10. *President/Honoured Royal Lady* presents a short speech**
- 11. Request dignitaries to speak**
- 12. Use Short Form Closing:**
  - (a) CHAPLAIN Attends center station**
  - (b) Sing The Queen**
  - (c) Declare Lodge closed.**



## **INSTALLATION OF OFFICERS**

Officers are seated as for the meeting. Installing Officer is seated to the right of the *President/Honoured Royal Lady*

**PRESIDENT/HONOURED ROYAL LADY** - (turning to the Installing Officer on her right, who rises), **Installing Officer**, I now place in your hands the gavel and resign to you the station and duties of **PRESIDENT/HONOURED ROYAL LADY** of this Lodge.

**INSTALLING OFFICER** - By virtue of the authority vested in me, I shall now proceed with the Installation of Officers of this Lodge. I hereby appoint \_\_\_\_\_ as Installing Secretary and \_\_\_\_\_ as Assistant Installing Officer.

**INSTALLING OFFICER – TREASURER**, have all monies due the National Office been paid?

**TREASURER** - They have.

**INSTALLING OFFICER – Secretary**, has the required report on the Membership of the Lodge been completed and forwarded to the National Office with the accompanying Membership Fees?

**SECRETARY**- It has.

**INSTALLING OFFICER: (-O -O-O-)**

**INSTALLING OFFICER – Officers** of \_\_\_\_\_ Lodge No. \_\_\_ of the Canadian Royal Purple, your unselfish devotion to the cause of duty in the past year, while not individually rewarded, has earned the appreciation of the Society, which your labours have helped to build and strengthen. Please remove your collars.

**INSTALLING OFFICER – Secretary/Assistant Installing Officer**, you will call the names of the Officers elected for the ensuing year and they will assume the Office vacated by the retiring Officers .

*If holding the same position, stand and await instructions.*

**INSTALLING OFFICER - -O-O-O-**

**INSTALLING OFFICER** - Do you signify your willingness to accept the Office to which you have been chosen? If so, answer "I do."

**INSTALLING OFFICER** - You will assume the Obligation Sign, pronounce your name and repeat after me:

### **INSTALLATION OBLIGATION**

I, \_\_\_\_\_, promise to fulfill the duties of the position to which I have been chosen. I will endeavour to promote the interests of the Society and increase its Membership. I promise to deal honestly with this Lodge, its Members, and the National Directors. At the end of my term, I will deliver all property of the Lodge in my possession to my successor, or to the duly authorized representative of the Society. All this I promise to fulfill to the best of my ability.

### **INSTALLING OFFICER - (-O-)**

**INSTALLING OFFICER** - it becomes my duty to call your attention to the Regulations of the Society which completely set forth the duties of all Officers. It is required that these articles must be carefully read by each Officer before the next regular meeting, in order to acquaint yourself with your duties.

**ASSISTANT INSTALLING OFFICER** - Installing Officer, it gives me great pleasure to present to you, \_\_\_\_\_ who has been chosen for the Office of \_\_\_\_\_ for the ensuing year.

**Officers are introduced in the following order:**

*Pianist (appointed) (optional)*

*Inner and Outer Guards or Guard)*

*Historian (appointed)*

*Chaplain*

*Conductress*

*Secretary*

*Treasurer or Secretary/Treasurer*

*3rd Vice President/Lecturing Lady*

*2nd Vice President/Loyal Lady*

*1st Vice President/Associate Royal Lady*

*Immediate Past President /Immediate Past Honoured Royal Lady*

*President/Honoured Royal Lady*

*Installing Officer instructs each Officer as presented as follows. When their instructions are completed, the Installing Officer will ask them to put their collar on and be seated.*

*Lodges using tapes or other electronic media may install the operator as Pianist.*

**INSTALLING OFFICER: PIANIST** - \_\_\_\_\_, your duties are to supply musical accompaniment for all floor work. The Lodge relies on you to lend color and rhythm..

**INNER/OUTER/GUARD** - \_\_\_\_\_, your duties are to see that all regalia of the Lodge if used, is stored before leaving the meeting. You also attend to the Member's register, the door and the telephone, if necessary.

**CONDUCTRESS** - \_\_\_\_\_, your duties are to conduct Prospective Members in the Initiation Ceremony and receive and introduce visiting Members and guests. If property of the Lodge is used during the meeting, you shall distribute prior to and collect after the meeting and give to the I/O/Guard for storage.

**CHAPLAIN** - \_\_\_\_\_, your duties are to have charge of the devotional exercises of the Lodge, to assist in the Initiation Ceremony, to attend the Bible, and to repeat the Lodge Grace when required. You shall write words of comfort and offer condolence to the bereaved.

**HISTORIAN** - \_\_\_\_\_, the glory of every Lodge is its history and heritage. Your duties are to keep past records, and to record present activities and events so that the history of the Lodge may be preserved.

**TREASURER** - \_\_\_\_\_, your duties are to receive all monies due to the Lodge, and pay out the same as authorized by the Lodge. You shall keep a correct record of receipts and expenditures, and submit your books for audit annually.

**SECRETARY** - \_\_\_\_\_, your duties are to keep a correct record of the proceedings of the Lodge, preserve and file all reports, and attend to correspondence. You will receive the signature of all Members to the Bylaws of the Lodge.

**SECRETARY/TREASURER** - \_\_\_\_\_ your duties are to keep a correct record of all the proceedings of the Lodge, preserve and file all reports and attend to the correspondence. You will receive the signatures of all Members to the Bylaws of the Lodge. You will receive all monies due the Lodge and pay out same as authorized by the Lodge. You shall keep a correct record of receipts and expenditures and submit your books for audit annually.

**3rd VICE-PRESIDENT/LECTURING LADY** - \_\_\_\_\_, your duties are to assist in the Initiation Ceremony and give instruction on the principle of Love. In the absence of your higher ranking Officers, it becomes your duty to preside over the sessions of the Lodge.

**2ND VICE PRESIDENT/LOYAL LADY** - \_\_\_\_\_, your duties are to assist in the Initiation Ceremony and give instruction on the principle of Justice. In the absence of your higher ranking Officers, it becomes your duty to preside over the sessions of the Lodge

**1ST VICE PRESIDENT/ASSOCIATE ROYAL LADY-** \_\_\_\_\_, your duties are to act as coordinator of Committees, assist in preserving order, and act for the President in her absence.

**PRESIDENT/HONOURED ROYAL LADY in their absence. You will assist in the Initiation Ceremony and give instruction on the principle of Charity.**

**IMMEDIATE PAST PRESIDENT/IMMEDIATE PAST HONOURED ROYAL LADY - \_\_\_\_\_, as you retire from the position of President/Immediate Past Honoured Royal Lady, we honour you with the plaudit, "Well done, thou good and faithful servant." I proclaim you Immediate Past President (Immediate Past Honoured Royal Lady). Your presence and advice are desired at all times.**

If Immediate Past Honoured Royal Lady is serving a second term, Installing Officer says:

**As you serve this Lodge again as Immediate Past President/Immediate Past Honoured Royal Lady, we honor you with the plaudit "Well done, thou good and faithful servant." I proclaim you Immediate Past President/(Immediate Past Honoured Royal Lady.**

**PRESIDENT/HONOURED ROYAL LADY- \_\_\_\_\_, the Position to which you have been chosen is the highest within this Lodge. You are the Leader and should be the guiding and directing force. You are to decide all questions directly by the law. Personal opinions or preferences must never be allowed to govern the PRESIDENT/HONOURED ROYAL LADY. Any discordance may be eliminated and every difficulty adjusted by your tact and discretion. The headstrong are to be restrained, the timid encouraged, and the indifferent stimulated by your prudence, your guidance, and your zeal. You may make yourself the friend and comforter of every Member. Guard all the interests of your Lodge, increase its Membership and keep a watchful eye in its general welfare, so that when the term for which you have been chosen shall have expired, you may receive the plaudit, "Well done, thou good and faithful servant."**

*When all Officers have been installed:-*

**INSTALLING OFFICER - Chaplain, we will close this ceremony in prayer. (-O-O-O-)**

**CHAPLAIN: Oh Lord, Bless the Officers who have taken their Obligations and give them wisdom and strength as they perform their duties throughout the year. Amen.**

**INSTALLING OFFICER - (-O-)**

**INSTALLING OFFICER - Now, by virtue of the authority vested in me, I declare the Officers of \_\_\_\_\_ Lodge No. \_\_\_\_, of the Canadian Royal Purple Society installed for the ensuing term or until their successors shall be chosen and duly installed. I now surrender into your keeping the gavel, and I trust that your Lodge may have a very prosperous year.**

The above procedure is used to install an Officer who was absent from the Installation Ceremony (also see Section 5 Ceremonies and Drills)